

A

Blades
for Large-Bone Power Systems

A-2

Blades
for Small-Bone Power Systems

A-15

Sternum Saw Blades

A-31

Burs

A-34

Rasps

A-40

K-wires + Steinmann Pins

A-41

Twist Drills + Taps

A-43

MICROAIRE® and Linvatec®

MICROAIRE®
For Surgery. For Life.™

Blades, Burs, Rasps, K-wires, Steinmann Pins, Twist Drills and Taps

BLADES for Large-Bone Power Systems

MicroAire® was the first company to offer double-sterile-packaged replacement large-power blades, and our commitment to value pricing and first-class service continues today.

For use with the following instruments:

MicroAire® Series 7000

Hall® PowerPro®, Versipower® and Series 4, PowerPro, M-Power, M-Power²



StableCut®

- Patented tooth design
- Aggressive angles cut along a straight path
- Increased ejection of debris
- Decreased friction reduces bone necrosis and implant failure
- Top choice of implant companies and orthopedic surgeons



Aggressive Offset

- Tooth geometry similar to PhotoEtch Aggressive blade
- Two rows of teeth formed by bending alternating teeth away from the surface of the blade

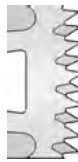

PhotoEtch Aggressive

- Stainless steel photo-chemically etched into a dual-thickness blade
- Two rows of aggressive-angled teeth
- Dual thickness reduces friction when used with a slotted cutting guide



Standard Offset

- Tooth geometry similar to Diamond-Ground blades
- Two rows of teeth formed by bending alternating teeth away from the surface of the blade



Diamond Ground

- Tooth pattern is cut into blade
- Angles are ground into the faces of teeth
- Two rows of sharp teeth
- Cutting thickness is same as the blade itself



D-Cut Replacement

- Small "double-teeth" on a straight path instead of a radius
- Channels between teeth help to move material away from cutting surface



Reciprocating Blades

- Used in total hip and total joint arthroplasty
- Available in both single- and double-edged patterns

Oscillating Saw Blades

MicroAire® and Hall® Large-Power Saws

D-Cut®

Part No.	Width (mm)	Usable Length (mm)	Cut Thickness (mm)	Material Thickness (mm)	TPI
Z011-089-090	11	90	0.89	0.89	16
Z011-119-090	11	90	1.19	1.19	16
Z011-127-090	11	90	1.27	1.27	16
Z018-089-090	18	90	0.89	0.89	16
Z018-127-090	18	90	1.27	1.27	16
Z018-127-100	18	100	1.27	1.27	16
Z018-135-090	18	90	1.35	1.35	16
Z025-089-075	25	75	0.89	0.89	16
Z025-089-090	25	90	0.89	0.89	16
Z025-107-090	25	90	1.07	1.07	16
Z025-119-090	25	90	1.19	1.19	16
Z025-127-090	25	90	1.27	1.27	16
Z025-127-100	25	100	1.27	1.27	16
Z025-135-090	25	90	1.35	1.35	16
Z025-147-090	25	90	1.47	1.47	16

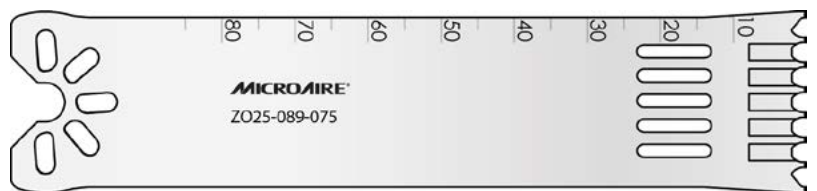
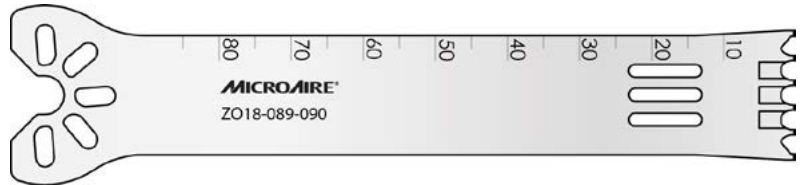
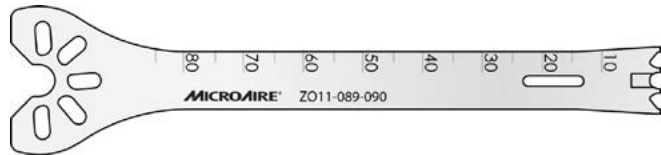

MicroAire® and Hall® Large-Power Saws

StableCut®

Part No.	Width (mm)	Usable Length (mm)	Cut Thickness (mm)	Material Thickness (mm)	TPI
Z0-72222	25	90	1.27	1.27	12
Z0-72622	25	90	1.19	1.19	12
Z0-72623	25	90	1.27	1.27	12
Z0-72625	25	90	1.37	1.37	12

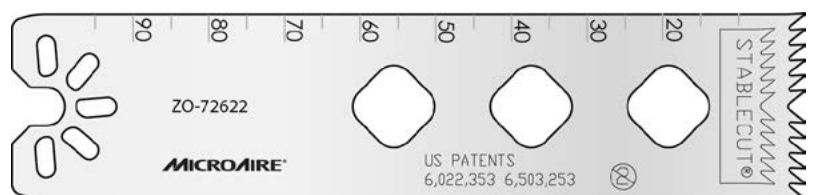
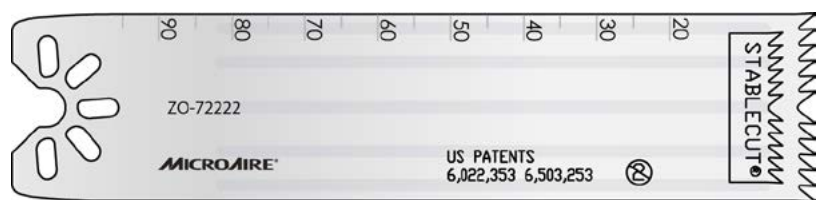

Part No.	Width (mm)	Usable Length (mm)	Cut Thickness (mm)	Material Thickness (mm)	TPI	
ZO-72689	25	90	0.89	0.89	12	
ZO-72709	21	90	1.0	1.0	12	
ZO-72719	13	90	1.19	1.19	12	
ZO-72730	19	105	1.27	1.27	12	
ZO-72737	21	90	1.35	1.35	12	
ZO-73416	25	90	1.0	1.0	12	
ZO-73417	25	90	1.47	1.47	12	
ZO-73418	25	90	1.37	1.37	12	
ZO-73419	25	90	1.19	1.19	12	

MicroAire® and Hall® Large-Power Saws StableCut®

Part No.	Width (mm)	Usable Length (mm)	Cut Thickness (mm)	Material Thickness (mm)	TPI
ZO-73420	13	90	1.27	1.27	12
ZO-73421	13	90	1.0	1.0	12
ZO-73422	13	90	1.37	1.37	12
ZO-73489	13	90	0.89	0.89	12
ZO-73613	21	90	1.19	1.19	12
ZO-73616	21	90	1.27	1.27	12

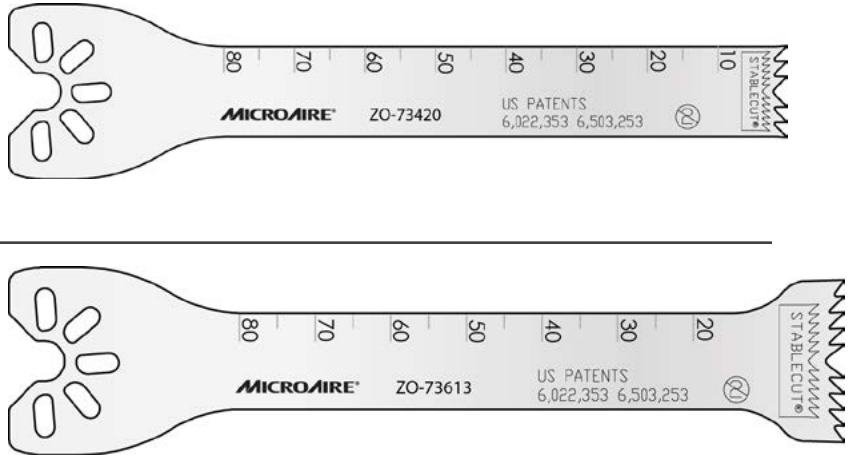





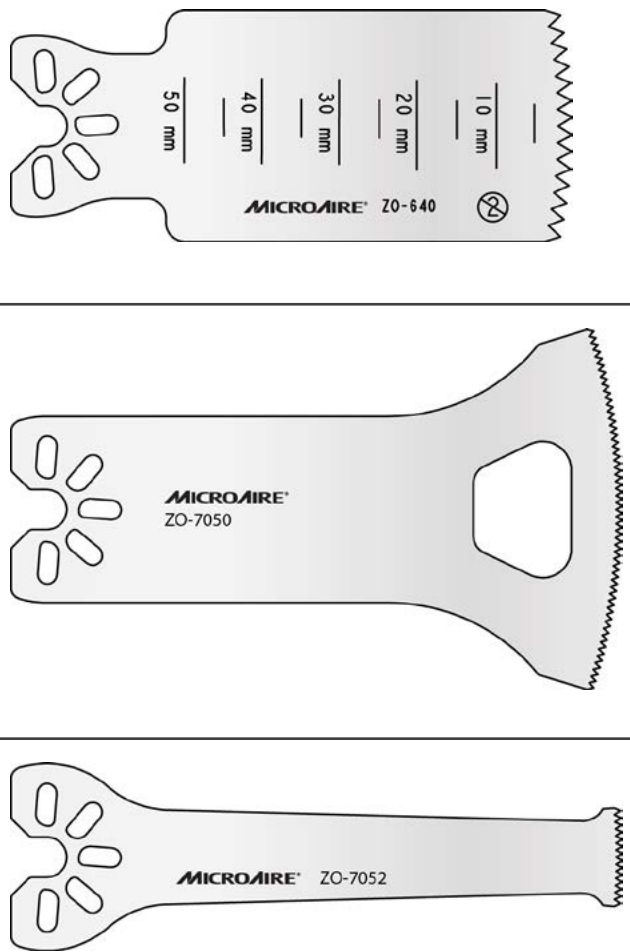



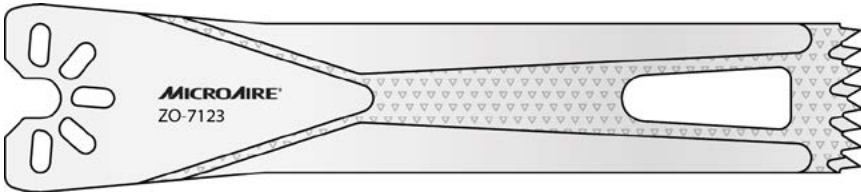

MicroAire® and Hall® Large-Power Saws All MicroAire® and Linvatec® (Except D-Cut®)



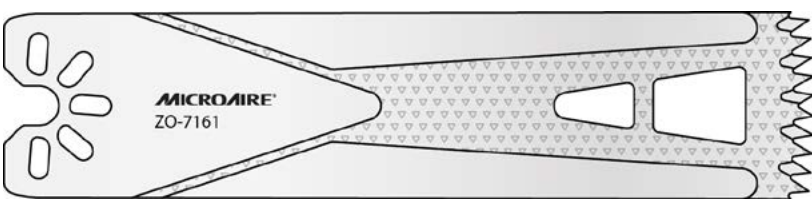

Part No.	Width (mm)	Usable Length (mm)	Cut Thickness (mm)	Material Thickness (mm)	TPI
ZO-640	30.5	50	1.0	0.64	12
ZO-7050	48	63	0.90	0.64	18
ZO-7052	13	64	0.90	0.64	18

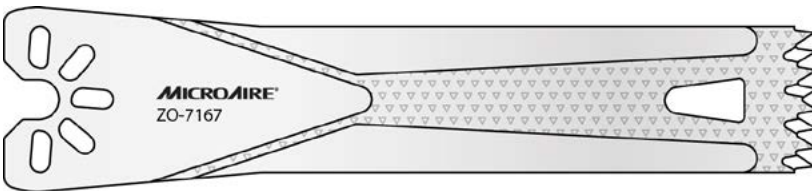



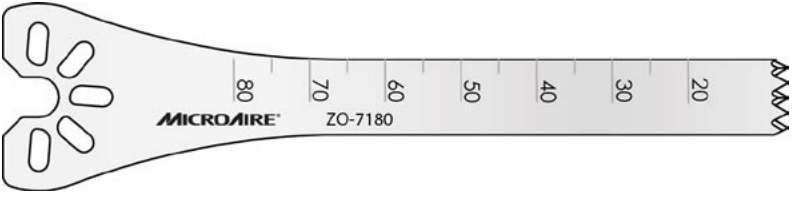
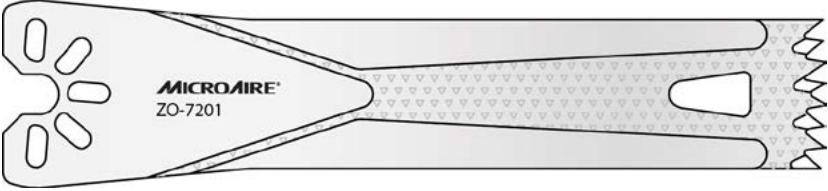

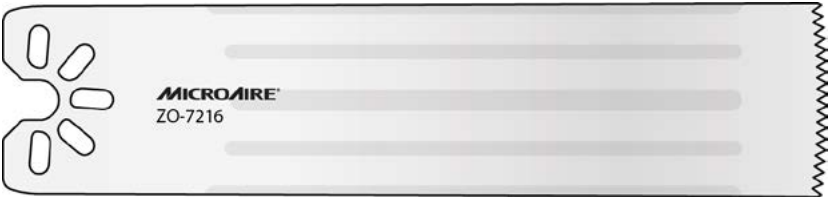

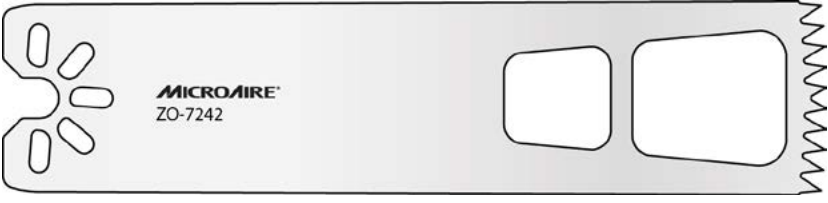
MicroAire® and Hall® Large-Power Saws All MicroAire® and Linvatec® (Except D-Cut®)

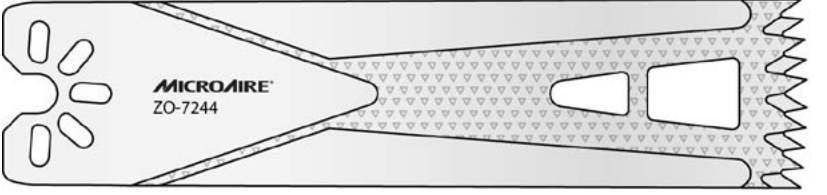

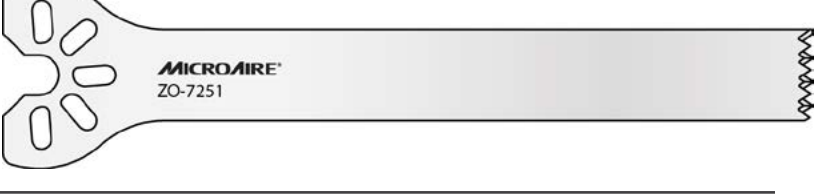

Part No.	Width (mm)	Usable Length (mm)	Cut Thickness (mm)	Material Thickness (mm)	TPI	
ZO-7053	19.5	63	0.90	0.64	18	
ZO-7055	32	68	1.50	1.20	18	
ZO-7111	25.4	90	1.40	1.27	12	
ZO-7123	19.5	95	1.27	1.27	10	
ZO-7145	11	30	1.10	0.64	18	
ZO-7151	33.3	63	0.90	0.64	18	

Part No.	Width (mm)	Usable Length (mm)	Cut Thickness (mm)	Material Thickness (mm)	TPI	
ZO-7154	19.5	71	1.35	1.20	18	
ZO-7156	33.5	64	0.90	0.80	18	
ZO-7161	25.4	90	1.27	1.27	10	
ZO-7163	25.4	90	1.37	1.37	10	
ZO-7165	25.4	90	1.47	1.47	10	
ZO-7166	32	63	0.90	0.80	10	
ZO-7167	19.5	90	1.20	1.20	10	
ZO-7172	19.5	71	0.90	0.80	18	

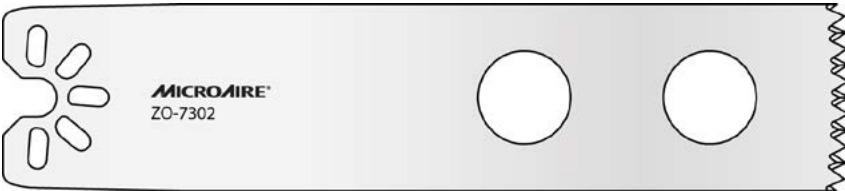
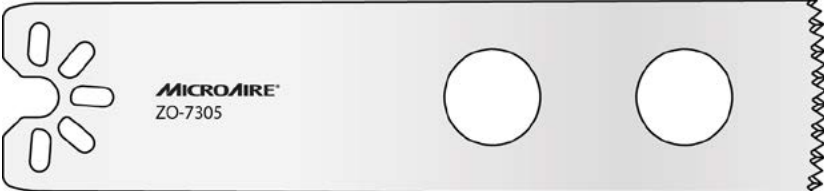
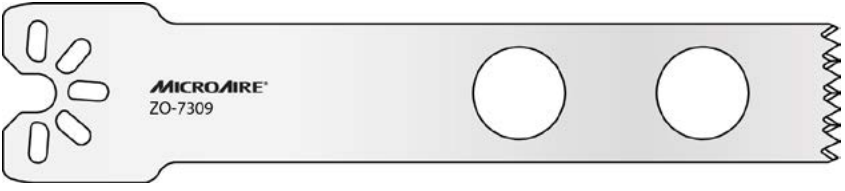
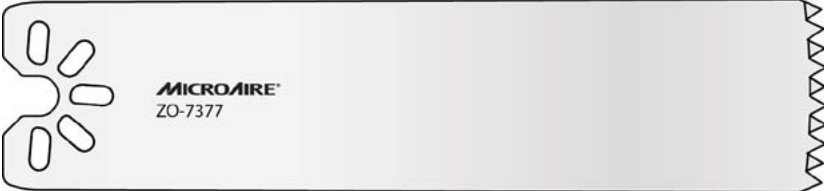

Part No.	Width (mm)	Usable Length (mm)	Cut Thickness (mm)	Material Thickness (mm)	TPI	
ZO-7180	10	85	1.27	1.27	12	
ZO-7201	19.5	90	1.27	1.27	10	
ZO-7205	25.4	90	1.0	0.90	12	
ZO-7216	25.4	90	1.35	1.35	12	
ZO-7240	25.4	80	1.40	1.20	12	
ZO-7241	19.5	80	1.40	1.27	10	
ZO-7242	25.4	90	1.40	1.27	10	

Part No.	Width (mm)	Usable Length (mm)	Cut Thickness (mm)	Material Thickness (mm)	TPI	
ZO-7243	25.4	90	0.90	0.80	10	
ZO-7244	25.4	90	1.50	1.50	10	
ZO-7245	13	70	1.50	1.27	12	
ZO-7246	25.4	90	0.90	0.90	12	
ZO-7250	13	90	1.0	0.90	16	
ZO-7251	12	89	1.35	1.35	12	
ZO-7274	19.5	86	0.90	0.80	18	

MicroAire® and Hall® Large-Power Saws All MicroAire® and Linvatec® (Except D-Cut®)

Part No.	Width (mm)	Usable Length (mm)	Cut Thickness (mm)	Material Thickness (mm)	TPI	
ZO-7277	19.5	71	0.90	0.80	10	
ZO-7278	19.5	80	0.9	0.80	10	
ZO-7302	25.4	95	0.89	0.89	12	
ZO-7305	25.4	90	1.20	1.20	12	
ZO-7309	19.1	90	0.89	0.89	12	
ZO-7377	25.4	90	1.50	1.50	12	
ZO-7380	19	85	1.35	1.35	12	

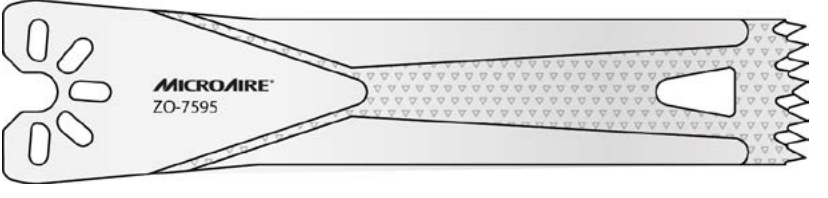
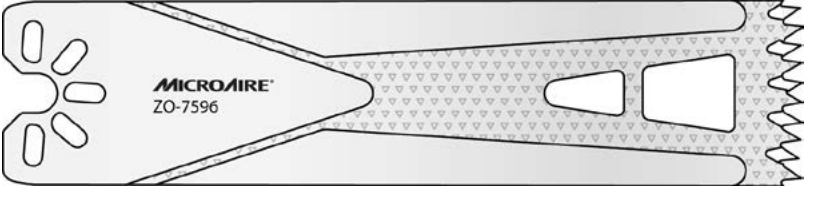
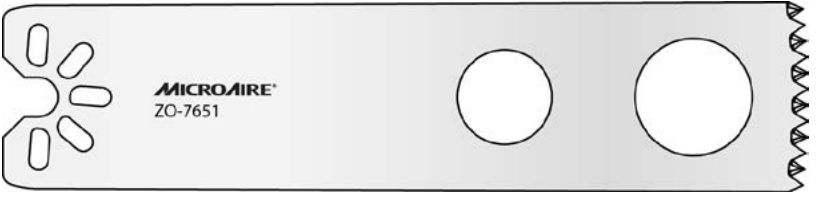

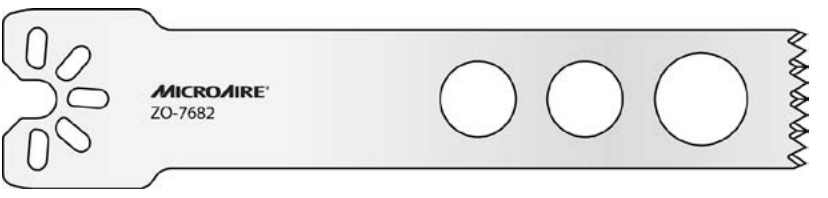
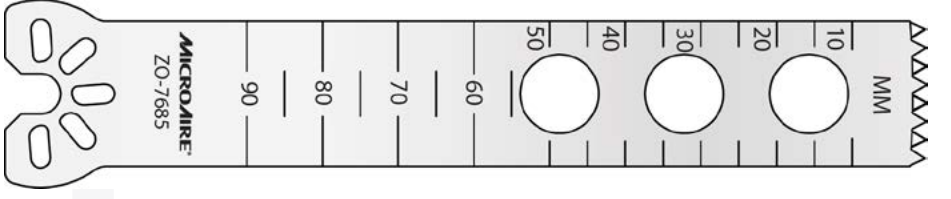
MicroAire® and Hall® Large-Power Saws All MicroAire® and Linvatec® (Except D-Cut®)



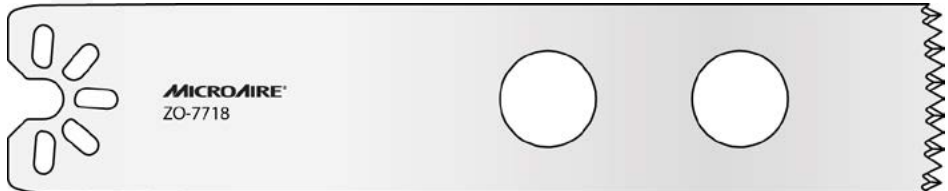

Part No.	Width (mm)	Usable Length (mm)	Cut Thickness (mm)	Material Thickness (mm)	TPI	
ZO-7390	19	90	1.35	1.35	12	
ZO-7595	19.5	90	0.90	0.90	10	
ZO-7596	25.4	90	0.90	0.90	10	
ZO-7651	25.4	90	1.19	1.19	12	
ZO-7654	13	90	1.19	1.19	12	
ZO-7682	19.1	85	1.27	1.27	12	
ZO-7685	19.1	105	1.19	1.19	12	

MicroAire® and Hall® Large-Power Saws All MicroAire® and Linvatec® (Except D-Cut®)

Part No.	Width (mm)	Usable Length (mm)	Cut Thickness (mm)	Material Thickness (mm)	TPI	
ZO-7689	12.7	94	0.89	0.89	12	
ZO-7718	25	105	1.24	1.24	12	

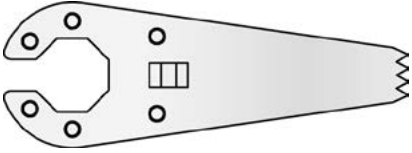



3M® and Linvatec® Power Instruments (Models Maxi-Driver® G120A, L120A and Maxion™ E220)

Part No.	Width (mm)	Usable Length (mm)	Cut Thickness (mm)	Material Thickness (mm)	TPI	
MO-121	15.2	50	1.60	1.0	10	
MO-122	31.5	50	1.60	1.0	10	
MO-123	15.2	50	1.10	0.60	13	

Part No.	Width (mm)	Usable Length (mm)	Cut Thickness (mm)	Material Thickness (mm)	TPI	
MO-124	31.5	50	1.10	0.60	12	
MO-125	6.6	20	1.0	0.60	15	
MO-126	15.2	50	1.60	1.0	12	
MO-127	31.5	50	1.60	1.0	12	
MO-128	31.5	50	0.90	0.60	22	
MO-129	15.5	50	0.90	0.60	22	

Reciprocating Saw Blades

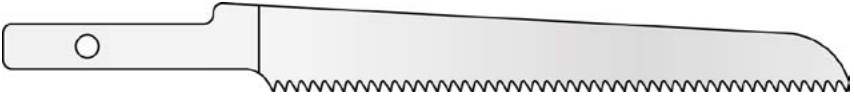

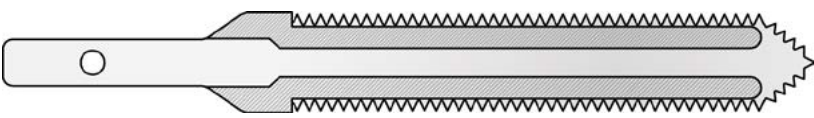
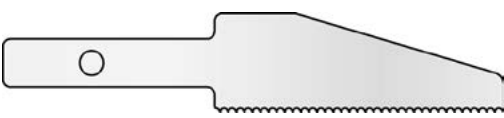







MicroAire® and Hall® Large-Power Saws

Part No.	Width (mm)	Usable Length (mm)	Cut Thickness (mm)	Material Thickness (mm)	TPI	
ZR-058	12.2	87.9	1.0	0.64	18	
ZR-059	9.4	52.8	1.0	0.64	18	
ZR-060	9.4	38.1	0.64	0.40	33	
ZR-061	12.2	80	1.80	1.27	18	
ZR-073	12.7	73.5	0.90	0.80	20	
ZR-079	12.7	76	0.90	0.90	16	
ZR-160	12.8	38.1	0.50	0.38	24	









BLADES for Small-Bone Power Systems

Oscillating Saw Blades





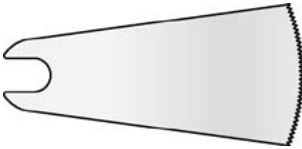

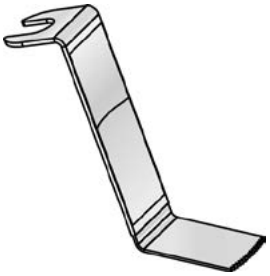
MicroAire® Oscillating Saw (Models 1700, 1710, 1970, 2700, 2710, 5922, 6700, and 6710)





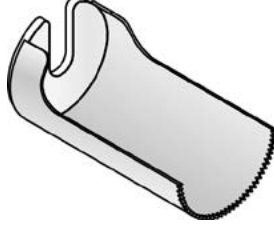

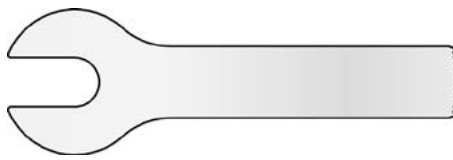

Part No.	Width (mm)	Usable Length (mm)	Cut Thickness (mm)	Material Thickness (mm)	TPI	 CAUTION: Do not use the long 1200 Series sagittal blades in these models of oscillating saws, as they will overstress the oscillating mechanism.
1700-001	10.2	11	0.5	0.3	36	
1700-002	10.2	12	0.5	0.3	36	
1700-003	13	16.5	0.5	0.3	36	
1700-007	10.2	11	0.5	0.3	36	
1700-008	10.2	12	0.5	0.3	36	
1700-009	10.2	7.7	0.5	0.3	36	
1700-010	10.2	9.3	0.5	0.3	36	
1700-012	10.2	10.2	0.5	0.3	36	
1700-013	9.1	7	0.5	0.3	36	 

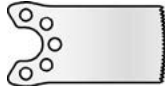

MicroAire® and Hall® Oscillating Saw (Models 1740, 1972, 2740, 5972 and 6740)

Part No.	Width (mm)	Usable Length (mm)	Cut Thickness (mm)	Material Thickness (mm)	TPI	 CAUTION: These blades cannot be used in MicroAire® oscillating saw models 1700, 1710, 1970, 1975, 1976, 2700, 2710, 6700, and 6710.
ZO-060	5.8	12	0.6	0.4	36	
ZO-061	9.7	12	0.6	0.4	36	
ZO-062	5.8	18.5	0.6	0.4	36	
ZO-063	9.7	18.5	0.6	0.4	36	
ZO-064	5.8	28.5	0.6	0.4	36	
ZO-065	9.7	28.5	0.6	0.4	36	
ZO-066	18.5	28.5	0.6	0.4	36	
ZO-067	5.8	13.5	0.6	0.4	36	
ZO-068	9.7	13.5	0.6	0.4	36	
ZO-069	9.7	13.5	0.6	0.6	36	

MicroAire® and Hall® Oscillating Saw (Models 1740, 1972, 2740, 5972 and 6740)



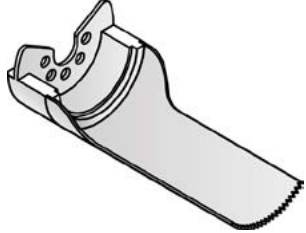

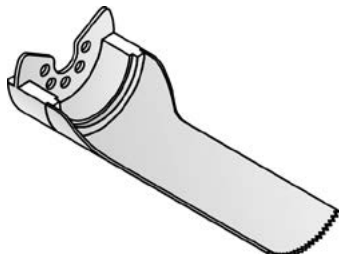
Part No.	Width (mm)	Usable Length (mm)	Cut Thickness (mm)	Material Thickness (mm)	TPI	
ZO-070	9	11.9	0.6	0.4	33	
ZO-071	13.5	21.6	0.6	0.4	33	
ZO-072	18	22.9	0.6	0.4	33	
ZO-073	9.7	31.2	0.6	0.4	36	
ZO-076	45	16	0.7	0.4	18	
ZO-077	9.4	40.1	0.6	0.4	22	
ZO-165	9.7	27.6	0.6	0.4	36	





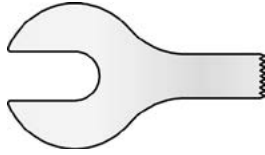
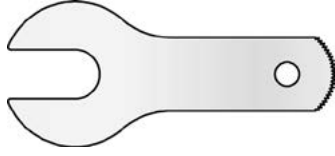

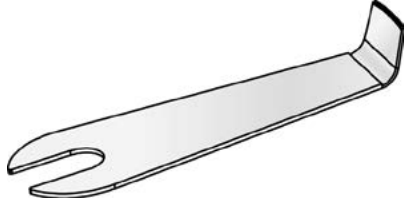
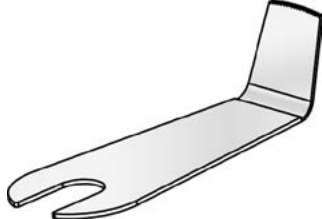
Part No.	Width (mm)	Usable Length (mm)	Cut Thickness (mm)	Material Thickness (mm)	TPI	
ZS-360	5.5	11	0.5	0.4	34	
ZS-361	10	11	0.5	0.4	34	
ZS-362	5.5	17.5	0.5	0.4	34	
ZS-363	10	17.5	0.5	0.4	34	
ZS-364	5.5	27.5	0.5	0.4	36	
ZS-365	10	27.5	0.5	0.4	36	
ZS-366	18.5	27	0.5	0.4	34	
ZS-367	5.8	13.5	0.6	0.4	36	
ZS-368	9.6	14	0.6	0.4	36	
ZS-369	10	33.5	0.5	0.4	34	





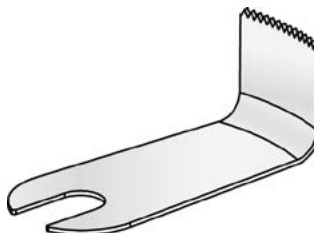

Part No.	Width (mm)	Usable Length (mm)	Cut Thickness (mm)	Material Thickness (mm)	TPI	
ZS-370	8.9	13.2	0.6	0.4	33	
ZS-371	13.5	23.1	0.6	0.4	33	
ZS-372	18	29	0.6	0.4	33	
ZS-373	13.5	28.7	0.6	0.4	33	

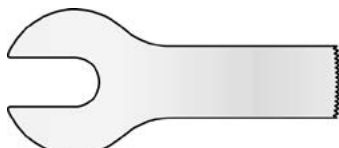
Sagittal Saw Blades



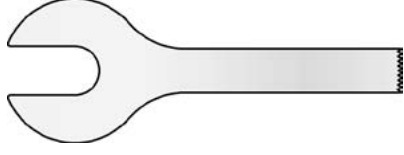
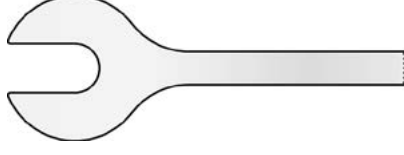

MicroAire® and Hall® Sagittal Saw (Models 1955, 2250, 5955, 6250, 6670, and 6673)

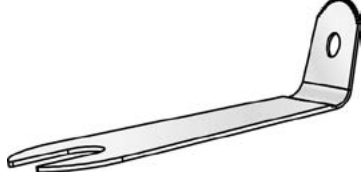
Part No.	Width (mm)	Usable Length (mm)	Cut Thickness (mm)	Material Thickness (mm)	TPI	
ZS-015	5.8	15	0.6	0.4	22	
ZS-018	9.7	24.4	0.6	0.4	36	
ZS-027	19.1	41	0.6	0.4	36	
ZS-028	9.4	7.1	0.6	0.4	36	
ZS-029	9.4	13.5	0.6	0.4	36	
ZS-030	19.1	25.4	0.6	0.4	22	
ZS-031	19.1	41	0.6	0.4	22	



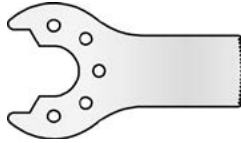
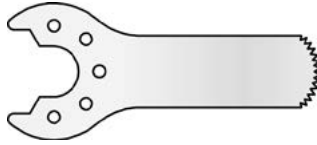

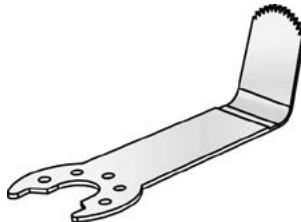
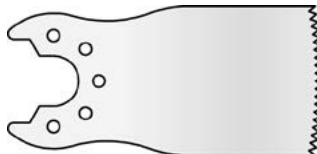
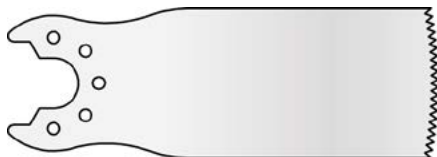
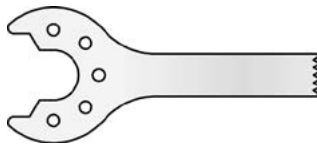

Part No.	Width (mm)	Usable Length (mm)	Cut Thickness (mm)	Material Thickness (mm)	TPI	
ZS-032	5.8	25.4	0.6	0.4	22	
ZS-033	14	41	0.6	0.4	22	
ZS-034	5.8	8.9	1.0	0.6	22	
ZS-035	5.8	17.3	1.0	0.6	22	
ZS-036	14	16	1.0	0.6	18	
ZS-037	14	25.4	0.6	0.4	22	
ZS-038	9.4	25.4	0.6	0.4	36	
ZS-038A	9.4	25.4	0.6	0.4	18	
XZS-038	9.5	25.4	1.0	0.8	22	

Part No.	Width (mm)	Usable Length (mm)	Cut Thickness (mm)	Material Thickness (mm)	TPI	
ZS-039	4.5	25.4	0.6	0.4	36	
ZS-040	9.4	41	0.6	0.4	36	
ZS-041	5.8	33.5	0.6	0.4	36	
ZS-042	4.3	35.6	0.6	0.4	36	
ZS-043	9.5	25.4	0.6	0.4	18	
ZS-104	9.4	15	0.6	0.4	36	
ZS-128	10.4	8.1	0.5	0.4	36	
ZS-129	10.4	13.5	0.5	0.4	36	

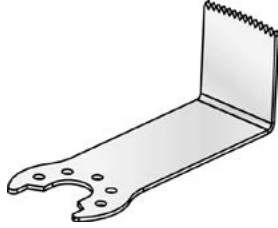
MicroAire® and Hall® Sagittal Saw (Models 1950, 1955, 2250, 5950, 5955, 6670, 6672, and 6673)

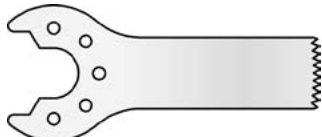
Part No.	Width (mm)	Usable Length (mm)	Cut Thickness (mm)	Material Thickness (mm)	TPI	
ZS-304	9.4	15	0.6	0.4	36	
ZS-318	9.5	25.4	0.5	0.4	31	
ZS-327	19.1	41	0.6	0.4	36	
ZS-329	9.7	14	0.56	0.4	34	
ZS-330	19.5	25.5	0.6	0.4	18	
ZS-331	19.5	41	0.6	0.4	18	
ZS-332	5.6	25.4	0.6	0.4	18	
ZS-333	14	41	0.6	0.4	18	

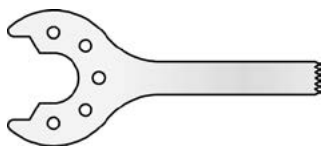
MicroAire® and Hall® Sagittal Saw (Models 1950, 1955, 2250, 5950, 5955, 6670, 6672, and 6673)

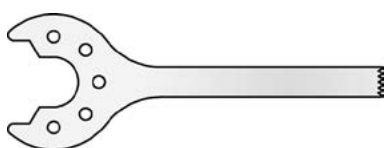
Part No.	Width (mm)	Usable Length (mm)	Cut Thickness (mm)	Material Thickness (mm)	TPI	
ZS-334	5.8	9	1.0	0.6	22	
ZS-336	14	16	1.0	0.6	18	
ZS-337	14	25.4	0.6	0.4	18	
ZS-338	9.4	25.4	0.5	0.4	34	
XZS-338	9.5	25.4	1.0	0.8	34	
ZS-339	4.5	25.4	0.6	0.4	34	
ZS-340	9.5	41	0.5	0.4	34	
ZS-341	6	34	0.5	0.4	34	
ZS-342	4	34	0.5	0.4	34	

MicroAire® and Hall® Sagittal Saw (Models 1950, 1955, 2250, 5950, 5955, 6670, 6672, and 6673)

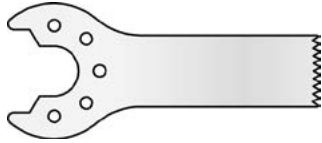
Part No.	Width (mm)	Usable Length (mm)	Cut Thickness (mm)	Material Thickness (mm)	TPI	
ZS-343	9.5	25.4	0.6	0.4	18	

MicroAire® TPS, CORE, RemB, and Command 2 Stryker-style Blades

MicroAire® and Hall® Sagittal Saw (Models 1950, 1955, 2250, 5950, 5955, 6670, 6672, and 6673)

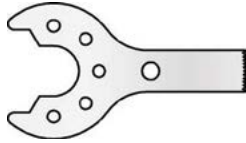
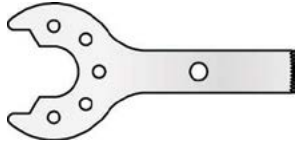

Part No.	Width (mm)	Usable Length (mm)	Cut Thickness (mm)	Material Thickness (mm)	TPI	
ZS-103	7	13	0.4	0.4	32	
ZS-105	9	17	0.4	0.4	32	
ZS-114	7	16	0.4	0.4	32	
ZS-115	7	29.5	0.4	0.4	32	
ZS-125	9	31	0.4	0.4	32	
ZS-225	9	31	0.4	0.4	22	
ZS-410	5.5	9.5	0.4	0.4	32	

Part No.	Width (mm)	Usable Length (mm)	Cut Thickness (mm)	Material Thickness (mm)	TPI	
ZS-412	5.5	18	0.4	0.4	32	
ZS-414	5.5	22	0.4	0.4	32	

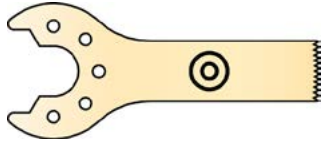
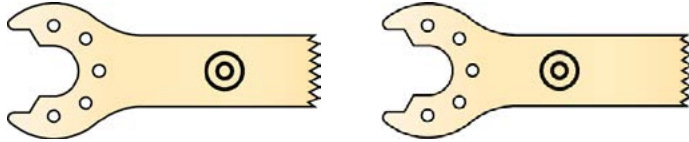



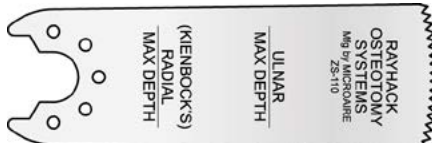



Titanium Nitride-Coated ACL Blades

Part No.	Width (mm)	Usable Length (mm)	Cut Thickness (mm)	Material Thickness (mm)	TPI	
ZS-382	8	12	0.6	0.4	18	
ZS-390	9.5	10	0.6	0.4	18	
ZS-395	9.5	15	0.6	0.4	18	



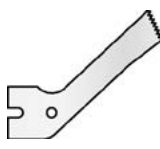
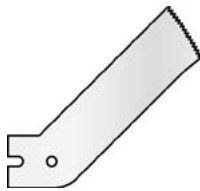



For the Wright® Medical Technologies Rayhack® System

Part No.	Width (mm)	Usable Length (mm)	Cut Thickness (mm)	Material Thickness (mm)	TPI	
ZS-110	19.1	40	0.6	0.5	22	
ZS-510	14	40	0.6	0.5	22	

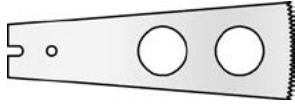
MicroAire® Sagittal Saw (Models 1220, 1920T, 1920, 1922, 2200, 5922 and 6200)

Part No.	Width (mm)	Usable Length (mm)	Cut Thickness (mm)	Material Thickness (mm)	TPI	
1200-001	12.7	19.8	0.5	0.3	36	
1200-003	12.7	24.3	0.5	0.3	36	
1200-005	6.9	19.8	0.5	0.3	36	
1200-006	4.1	17	0.5	0.3	36	
1200-007	4.3	15	0.5	0.3	32	
1200-008	7.9	21.5	0.5	0.3	36	
1200-009	10.2	17.8	0.5	0.3	36	
1200-010	10.2	13.7	0.5	0.3	36	
1200-011	8.1	6.6	0.5	0.3	36	
1200-012	9.1	13.7	0.5	0.3	36	



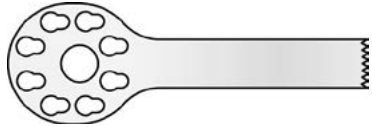
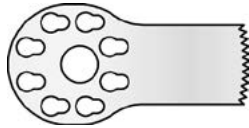

MicroAire® Sagittal Saw (Models 1220, 1920T, 1920, 1922, 2200, 5922 and 6200)

Part No.	Width (mm)	Usable Length (mm)	Cut Thickness (mm)	Material Thickness (mm)	TPI	
1200-013	12.7	29	0.5	0.3	36	
1200-014	7.5	15	0.5	0.3	36	
1200-017	5.8	18	0.5	0.3	36	
1200-018	10.2	18.3	0.5	0.3	36	
1200-019	6.9	28.7	0.5	0.3	36	
1200-019A	6.9	13.5	0.5	0.3	22	
1200-038	9.4	25.5	0.5	0.3	36	

Hall®(3M®) Mini-Driver K120 Sagittal Saw Insert

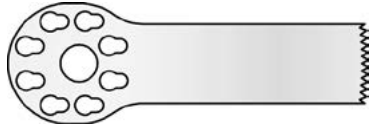





Part No.	Width (mm)	Usable Length (mm)	Cut Thickness (mm)	Material Thickness (mm)	TPI	
MS-121	6.4	15.7	1.0	0.7	27	
MS-122	6.4	31.7	1.0	0.7	26	
MS-123	10.4	15.7	1.0	0.7	27	









Hall®(3M®) Mini-Driver K120 Sagittal Saw Insert

Part No.	Width (mm)	Usable Length (mm)	Cut Thickness (mm)	Material Thickness (mm)	TPI	
MS-124	10.4	31.7	1.0	0.7	26	
MS-125	15.5	15.7	1.0	0.7	27	
MS-131	6.4	15.7	0.7	0.7	27	
MS-132	6.4	31.7	0.7	0.7	26	
MS-134	10.4	31.7	0.7	0.7	26	

Reciprocating Saw Blades

MicroAire® Reciprocating Saw Models 1400, 1945, 2420, 5945, 6400 and 6420

Part No.	Width (mm)	Usable Length (mm)	Cut Thickness (mm)	Material Thickness (mm)	TPI	
1400-001	8	25.4	0.7	0.4	32	
1400-002	8	38.1	0.7	0.4	32	
1400-003	4.3	12.7	0.9	0.5	30	
1400-004	4.3	12.7	0.9	0.5	30	
1400-005	5	22.9	0.6	0.4	30	
1400-006	9	40	0.8	0.5	24	

Part No.	Width (mm)	Usable Length (mm)	Cut Thickness (mm)	Material Thickness (mm)	TPI	
ZR-020	7.6	25.4	0.6	0.4	33	
ZR-021	9.4	39.1	0.6	0.4	33	
ZR-050	5.8	6.8	0.8	0.5	21	
ZR-051	5.0	17.2	0.8	0.5	21	
ZR-052	6.1	23.1	0.8	0.5	21	
ZR-053	8.1	25.1	0.8	0.5	21	
ZR-120	8.1	25.4	0.5	0.4	22	
ZR-154	7.4	23.6	0.6	0.4	36	
ZR-733	6.4	22.9	0.6	0.4	20	

STERNUM SAW BLADES

Sternum Saw Blades

Linvatec®

Sternum Saw

Model 5059-05

Part No.	Width (mm)	Usable Length (mm)	Cut Thickness (mm)	Material Thickness (mm)	TPI	
ZR-031	9.3	53.6	1.0	0.64	18	

MicroAire®

Sternum Saw

Model 4800

Linvatec®

Sternum Saw

Model 5059-05

Part No.	Width (mm)	Usable Length (mm)	Cut Thickness (mm)	Material Thickness (mm)	TPI	
ZR-032	9.4	34	1.0	0.6	18	

MicroAire®

Sternum Saw

Model 7800

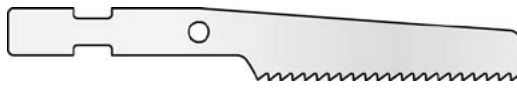
Part No.	Width (mm)	Usable Length (mm)	Cut Thickness (mm)	Material Thickness (mm)	TPI	
ZR-032M	9.4	34	1.0	0.6	18	
ZR-033M	9.4	34	1.0	0.6	16	

Linvatec®/ Hall®

Repeat Sternotomy Saw

Model 5057

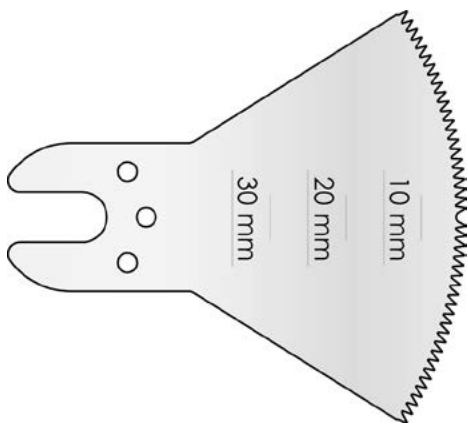
Part No.	Width (mm)	Usable Length (mm)	Cut Thickness (mm)	Material Thickness (mm)	TPI	
ZO-079	53.3	30	0.6	0.4	18	

MicroAire® Oscillating Saw Models 7200, 7205, 7600 and 7506

Linvattec® Oscillating Saw Models 5052 and 5044-02 PowerPro®, M-Power®, and M-Power®2

Part No.	Width (mm)	Usable Length (mm)	Cut Thickness (mm)	Material Thickness (mm)	TPI	
ZO-7079	53	35	0.6	0.4	22	
ZO-7125	42	50	1.1	0.64	22	
ZO-7137	83	30	1.0	0.64	22	

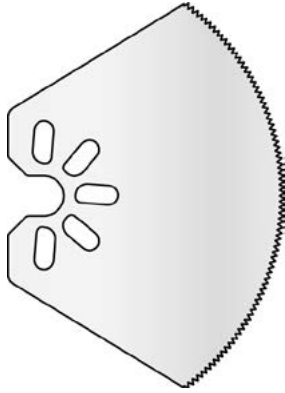
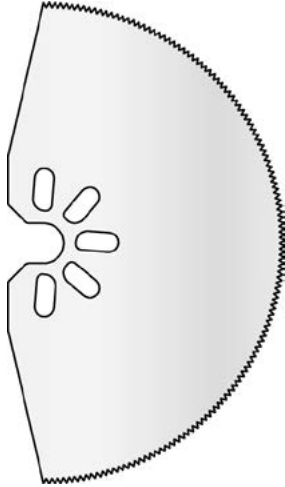
MicroAire® Oscillating Saw		Models 7200, 7205, 7600 and 7506		Linvatec® Oscillating Saw		Models 5052 and 5044-02 PowerPro®, M-Power®, and M-Power®2	
Part No.	Width (mm)	Usable Length (mm)	Cut Thickness (mm)	Material Thickness (mm)	TPI		
ZO-7225	51	19	0.7	0.4	18		
ZO-7226	63.5	19	0.7	0.4	18		

























BURS

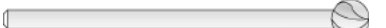









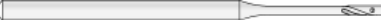







Medium-Length Burs

MicroAire®

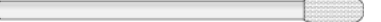
Drill with Built-on Medium Bur Guard

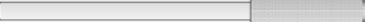
Models 1140, 1910, 1910T, 1930, 1932, 1940, 1940T, 2100, 2120, 2130, 2910, 2950, 5930, 6100, 6120, and 6130. Also fits Linvatec® Micro Drills with Medium Bur Guard.

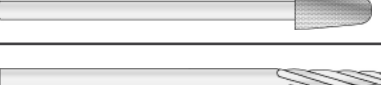















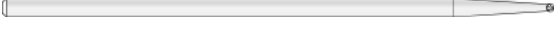

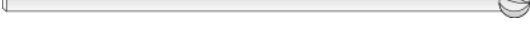
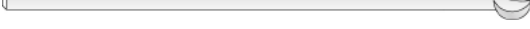

Type	Part No.	Head Size Diameter (mm)	Head Length (mm)	# of Flutes	Overall Length (mm)	 CAUTION: Do not use burs with head diameters larger than 4mm in the 1910, 1910T, 2130, 2910, 2950, or 6130 High Speed Drills. The burs may break and cause injury. Length must be between 47.8mm–56.9mm. Do not use long burs without the proper bur guard.
End-Side Cut Carbide (Suture Holes)	ZB-100	0.8	4.6	6	50.8	
Side-Cut Carbide	ZB-101	1	5.1	6	50.8	
	ZB-104	1.5	7.6	6	50.8	
Side-Cut Tapered Carbide	ZB-102	1.5	10.2	6	50.8	
	ZB-103	1	5.1	6	50.8	
	ZB-106	2	7.6	6	50.8	
	ZB-113	2	5	6	50.8	
	ZB-114	2	19.1	6	56.9	
Lindemann Stainless Steel	ZB-112	2.3	31.5	4	66.5	
Round-Cut Carbide	ZB-121	1	1	6	50.8	
	ZB-122	1.5	1.5	6	50.8	
	ZB-124	2	2	6	50.8	
	ZB-125	2.4	2.4	6	50.8	
	ZB-126	3	3	8	50.8	
	ZB-128	4	4	8	48.3	
	ZB-130	5	5	10	48.3	
	ZB-132	6.5	6.5	10	48.3	
Oval-Cut Carbide	ZB-136	4	7.9	8	47.8	
	ZB-138	5.5	9.9	10	47.8	
Swanson Pilot Point Reamer	ZB-142	2	8.6	4	57.2	
	ZB-143	3	13.7	5	61.2	
	ZB-144	4	16.8	6	62	
	ZB-145	5	18.5	8	63	

Type	Part No.	Head Size Diameter (mm)	Head Length (mm)	# of Flutes	Overall Length (mm)	 CAUTION: Do not use burs with head diameters larger than 4mm in the 1910, 1910T, 2130, 2910, 2950, or 6130 High Speed Drills. The burs may break and cause injury. Length must be between 47.8mm–56.9mm. Do not use long burs without the proper bur guard.	
Wire Pass Drill	ZB-147	1.1	19.1	2	50.8		
	ZB-148	1.5	19.1	2	50.8		
	ZB-149	2	19.1	2	50.8		
	ZB-447	1.1	19.1	2	36.8		
	ZB-448	1.5	19.1	2	36.8		
	ZB-449	2.0	19.1	2	36.8		
Barrel-Cut Carbide	ZB-152	2	10.2	8	50.8		
	ZB-154	4	10.2	12	47.8		
Round Diamond	ZB-160	2	2	N/A	50.8		
	ZB-162	3	3	N/A	50.8		
	ZB-164	4	4	N/A	47.8		
	ZB-168	6	6	N/A	47.8		
Oval Diamond	ZB-170	4	7.9	N/A	48.3		
	ZB-180	4	15	N/A	48.3		
	ZB-181	7	15	N/A	48.3		
Diamond Dermabraders	ZB-182	10.5	15	N/A	49		
	ZB-183	10.2	15	N/A	49.3		
	ZB-184	5	10.2	N/A	49.3		
Lindemann Carbide	ZB-190	1.9	15.2	4	48.3		
Shannon 44 (Stainless Steel)	ZB-192	2.3	14	3	50.8		

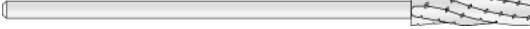
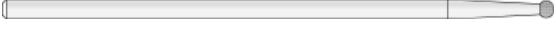
Long Burs

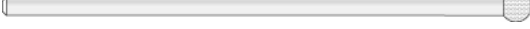
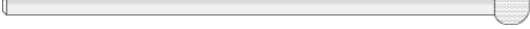
Drill with 1100-005 Bur Guard 1140, 1930, 1932, 1940, 1940T, 2100, 2120, 5930 6100, and 6120
 Drill with 2910-011 Bur Guard 2130, 2910, 2950, and 6130 high-speed drills
 Drill with 1910-011 Bur Guard 1910 and 1910T high-speed drills
 Also fits Linvatec® Micro Drills with Long Bur Guard.













MicroAire®

All require long bur guard.						 CAUTION: Do not use burs with head diameters larger than 4mm in the 1910, 1910T, 2130, 2910, 2950, or 6130 High Speed Drills. The burs may break and cause injury. Length must be between 69.8mm–80mm. Do not use long burs without the proper bur guard.
Type	Part No.	Head Size Diameter (mm)	Head Length (mm)	# of Flutes	Overall Length (mm)	
Lindemann Carbide	ZB-200	1.9	15.2	4	69.9	
Side-Cut Tapered Carbide	ZB-203	1.7	12.2	6	69.9	
Side-Cut Carbide	ZB-204	1.5	7.6	6	73.2	
Side-Cut Tapered Carbide	ZB-206	2	7.6	6	73.2	
	ZB-214	2	19.1	6	80	
Round-Cut Carbide	ZB-220	1	1	6	73.2	
	ZB-222	1.5	1.5	6	73.2	
	ZB-224	2	2	6	73.2	
	ZB-226	3	3	8	73.2	
	ZB-228	4	4	8	69.9	
	ZB-230	5	5	10	69.9	
	ZB-232	6.5	6.5	10	69.9	
Oval-Cut Carbide	ZB-236	4	7.9	8	69.9	
	ZB-238	5.5	9.9	10	69.9	
Barrel-Cut Carbide	ZB-252	2	10.2	8	73.2	
	ZB-254	4	10.2	12	69.9	
Round Diamond	ZB-260	2	2	N/A	73.2	
	ZB-262	3	3	N/A	73.2	
	ZB-264	4	4	N/A	69.1	
	ZB-266	5	5	N/A	69.1	
	ZB-268	6	6	N/A	69.1	
Oval Diamond	ZB-270	4	7.9	N/A	69.9	
Shannon 44 (Stainless Steel)	ZB-292	2.3	14	3	69.9	

Extra-Long Burs

Drill with 1100-005 Bur Guard 1140, 1930, 1932, 1940, 1940T, 2100, 2120, 5930 6100, and 6120
 Drill with 2910-019 Bur Guard 2130, 2910, 2950, and 6130 high-speed drills
 Drill with 1910-019 Bur Guard 1910 and 1910T high-speed drills
 Also fits Linvatec® Micro Drills with Extra-Long Bur Guard.











MicroAire®

Type	Part No.	Head Size Diameter (mm)	Head Length (mm)	# of Flutes	Overall Length (mm)	 CAUTION: Do not use burs with head diameters larger than 4mm in the 1910, 1910T, 2130, 2910, 2950, or 6130 High Speed Drills. The burs may break and cause injury. Do not use long burs without the proper bur guard.
Side-Cut Tapered Carbide	ZB-306	2	7.6	6	95.3	
Round-Cut Carbide	ZB-322	1.5	1.5	6	95.3	
	ZB-324	2	2	6	95.3	
	ZB-326	3	3	8	95.3	
	ZB-328	4	4	8	95.3	
	ZB-330	5	5	10	95.3	
Oval-Cut Carbide	ZB-336	4	7.9	8	95.3	
	ZB-338	5.5	9.9	10	95.3	
Round Diamond	ZB-360	2	2	N/A	94.5	
	ZB-362	3	3	N/A	94.5	
	ZB-364	4	4	N/A	95.3	
	ZB-366	5	5	N/A	94.5	

Oral Surgery Burs

MicroAire® Drill

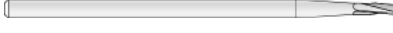
Models 1140, 1910, 1910T, 1930, 1932, 1940, 1940T, 2100, 2120, 2130, 2910, 2950, 5930, 6100, 6120, and 6130 high-speed drills. Also fits Linvatec® Micro and High Speed Drills with Medium Bur Guard.





Type	Part No.	Head Size Diameter (mm)	Head Length (mm)	# of Flutes	Overall Length (mm)	
Round-Cut Carbide	ZB-70	2.3	2.3	8	50.8	
Side-Cut Carbide	ZB-71	1.6	4.4	6	50.8	
Tapered Side-Cut Carbide	ZB-72	1.2	4	6	50.8	
	ZB-73	1.6	4.6	6	50.8	
	ZB-74	2.1	4.6	6	50.8	
Round-Cut Carbide	ZB-75	1.8	1.6	6	50.8	
Round-End Carbide	ZB-76	1.2	4.3	6	50.8	
Side-Cut Carbide	ZB-77	1.2	4.3	6	50.8	
Cross-Cut Fissure	ZB-78	2.1	4.6	8	50.8	

*See page A-39 for Drill Nose Shield

Cebotome™ Drill Burs

Linvatec® (Hall®)



Cebotome™ drills

Type	Part No.	Head Size Diameter (mm)	Head Length (mm)	# of Flutes	Overall Length (mm)	
Side Cutting	ZB-582	6	24.3	2	42.7	
Round Cutting	ZB-584	7	6.1	10	30.2	
	ZB-585	8	8	10	31.3	
	ZB-586	9	8.4	10	32.5	

Short Round Burs

Linvatec® (Hall®)







Osteon™ drill system

Part No.	Head Size Diameter (mm)	Head Length (mm)	# of Flutes	Overall Length (mm)	
ZB-617	6.5	6.5	10	30	
ZB-618	5	5	10	30	
ZB-619	4	4	8	30	

Medium Round Burs

Linvatec® (Hall®)









Osteon™ drill system

Part No.	Head Size Diameter (mm)	Head Length (mm)	# of Flutes	Overall Length (mm)	
ZB-625	6.5	6.5	10	38	
ZB-626	5	5	10	38	
ZB-627	4	4	8	38	
ZB-628	3	3	8	38	
ZB-647	5	5	0	38	
ZB-648	4	4	0	38	

Long Round Burs

Linvatec® (Hall®)

Osteon™ drill system

Part No.	Head Size Diameter (mm)	Head Length (mm)	# of Flutes	Overall Length (mm)	
ZB-640	1.5	1.5	6	48	
ZB-642	2	2	6	48	
ZB-644	5	5	10	48	
ZB-645	4	4	8	48	
ZB-646	3	3	8	48	
ZB-650	5	5	0	48	
ZB-659	3	3	0	48	
ZB-662	2	2	0	48	
ZB-664	1	1	6	48	



1100-008

MicroAire® Drill Nose Shield

Special autoclavable silicone nose cap prevents blood and saline from entering the drill nose. Especially important during oral surgery where deposits can damage the bearing and gripping mechanism, resulting in overheating.

- For models 1930, 1932, 1940, 1940T, 2100, 2120, 2130, 2910, 2950, 5130, 5930, 5932, 6100, 6120, and 6130 drills
- Package of 10

RASPS

Rasps

MicroAire®

Reciprocating Saw



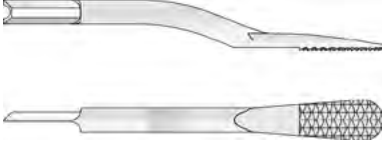
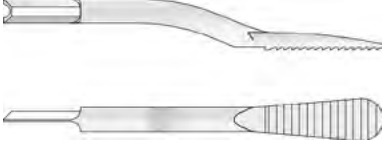



Model 1400

Type	Part No.	Width (mm)	Usable Length (mm)	
Cross-Serrated	1400-011	5.3	11	
Cottle	1400-013	5.6	15.5	

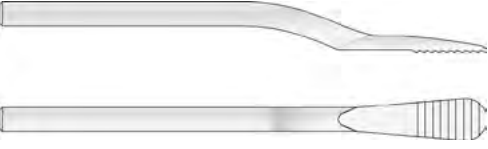
MicroAire®

Reciprocating Saw

Models 1945, 2420, 1915, 1915T, 5945, 6400 and 6420

Type	Part No.	Width (mm)	Usable Length (mm)	
Small Straight-Cut	ZR-080	5.5	9.5	
Large Straight-Cut	ZR-081	6.5	12.5	
Small Cross-Cut	ZR-082	5.5	9.5	
Large Cross-Cut	ZR-083	6.5	12.5	
Small Intramedullary	ZR-084	5.3	24.5	
Large Intramedullary	ZR-085	9.5	30.5	

K-WIRES + STEINMANN PINS

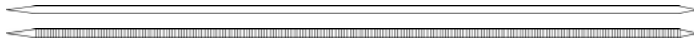

K-Wires

6-packs only. To order non-sterile, add "NS" to the end of the product number (e.g. 1600-XXXNS)

Length	Point Style	Type	Wire Diameter				
			0.7 mm / .028"	0.9 mm / .035"	1.1 mm / .045"	1.4 mm / .054"	1.6 mm / .062"
4"	Single Trocar	Smooth	1604-128	1604-135	1604-145	1604-154	1604-162
		Double Trocar	Smooth	1600-428	1600-435	1600-445	1600-454
		Threaded		1600-435T	1600-445T	1600-454T	1600-462T
6"	Double Trocar	Smooth	1600-628	1600-635	1600-645	1600-654	1600-662
		Threaded		1600-635T	1600-645T	1600-654T	1600-662T
9"	Single Trocar	Smooth		1600-9355	1600-9455	1600-9545	1600-9625
		Double Trocar	Smooth		1600-935	1600-945	1600-954
		Threaded		1600-935T	1600-945T	1600-954T	1600-962T



K-Wires with Wire Guide

MicroAire®

Pencil Grip Wire Driver

Models 1620, 1625, 1995 and 2600
6-packs only

Length	Point Style	Type	Wire Diameter				
			0.7 mm / .028"	0.9 mm / .035"	1.1 mm / .045"	1.4 mm / .054"	1.6 mm / .062"
5.5"	Double Trocar	Smooth	1600-020	1600-021	1600-022		1600-023
			1600-001NS	1600-002NS	1600-003NS		1600-004NS
		Wire Guide only (non-sterile) Color	1600-009NS Red	1600-010NS Blue	1600-011NS Yellow	1600-013NS White	1600-012NS Black



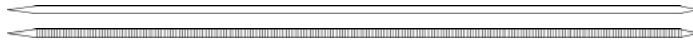

Steinmann Pins

6-packs only. To order non-sterile, add "NS" to the end of the product number (e.g. 1600-XXXNS)

Length	Point Style	Type	Wire Diameter						
			2.0 mm / 5/64"	2.4 mm / 3/32"	2.8 mm / 7/64"	3.2 mm / 1/8"	3.6 mm / 9/64"	4.0 mm / 5/32"	4.8 mm / 3/16"
9"	Single Trocar	Smooth	1620-509	1624-509	1628-509	1632-509	1636-509	1640-509	1648-509
		Threaded	1620-509T	1624-509T	1628-509T	1632-509T	1636-509T	1640-509T	1648-509T
	Double Trocar	Smooth	1620-109	1624-109	1628-109	1632-109	1636-109	1640-109	1648-109
		Threaded	1620-109T	1624-109T	1628-109T	1632-109T	1636-109T	1640-109T	1648-109T
	Single Diamond	Smooth	1620-609	1624-609	1628-609	1632-609	1636-609	1640-609	1648-609
		Threaded	1620-609T	1624-609T	1628-609T	1632-609T	1636-609T	1640-609T	1648-609T
	Double Diamond	Smooth	1620-709	1624-709	1628-709	1632-709	1636-709	1640-709	1648-709
		Threaded	1620-709T	1624-709T	1628-709T	1632-709T	1636-709T	1640-709T	1648-709T

K-Wire + Pin Protectors

Molded thermoplastic, protection from sharp points, and sold in sterile 4-packs.

For K-Wires	Wire Diameter			
	Color	0.7 mm / .028"	0.9 mm / .035"	1.1 mm / .045"
	1601-028 Yellow	1601-035 Blue	1601-045 White	1601-062 Green

For Steinmann Pins	Wire Diameter						
	Color	2.0 mm / 5/64"	2.4 mm / 3/32"	2.8 mm / 7/64"	3.2 mm / 1/8"	3.6 mm / 9/64"	4.0 mm / 5/32"
	1601-564 Pink	1601-332 Gray	1601-764 Tan	1601-180 Lavendar	1601-964 Brown	1601-532 Navy Blue	1601-316 Orange



TWIST DRILLS + TAPS

Standard Orthopaedic Twist Drills

MicroAire® Jacobs® Drill Couplers



Also fits all other standard Jacobs®-style Drill Couplers (Hall®, Stryker®, Synthes®, Aesculap®, DeSouter®, Brasseler®, etc.)

To order non-sterile, add "NS" to the end of the product number (e.g. 8054-XXXNS)



Type	Diameter (mm)	Length (mm)	MicroAire Part #	Replaces Zimmer®	
MicroAire Standard Twist Drills	1.6	127	8054-010	256-01-21	
	2.0		8054-011	256-01-22	
	2.4		8054-012	256-01-23	
	2.8		8054-013	256-01-24	
	3.2		8054-014	256-01-25	
	3.6	8054-015	256-01-26		
	4.0	127	8054-016	256-01-27	
	4.5		8054-017	256-01-28	
	4.8		8054-018	256-01-29	
	6.4		8054-019		
ECT® Twist Drills*	2.0	127	8054-020	2318-20	
	2.8		8054-021	2318-27	
	3.2		8054-022	2318-32	
	3.6		8054-023	2318-35	
	4.5		8054-024	2318-45	

*ECT® European Compression Technique

Small Power Instrument Twist Drills

MicroAire® Wire Driver		Models 1620, 1625, 1925, 1995 and 2600 with wire guide	Wire guide required (not included). Sold individually. Sterile or non-sterile; to order non-sterile, add "NS" to the end of the product number (e.g. 8051-XXXNS).
Diameter (mm)	Length (mm)	MicroAire Part #	
2.0	65	8051-120	
2.7	79	8051-127	
Wire Guide for Drills Sold in packs of 6 Non-sterile only		1600-012NS	

Standard Twist Drills with 2.34 mm Dental Bur Shank Sold individually. Sterile or non-sterile; to order non-sterile, add "NS" to the end of the product number (e.g. 8051-XXXNS)
 May be used in standard MicroAire® and Linvatec® Micro Drills

Diameter (mm)	Length (mm)	MicroAire Part #	 CAUTION: Do not operate above 10,000 RPM. Do not use in high-speed drill.
1.1	49	8051-011	
1.3	49	8051-013	
1.5	49	8051-015	
1.8	49	8051-018	
2.0	65	8051-020	
2.2	49	8051-021	
2.7	79	8051-027	
3.2	79	8051-032	
3.5	79	8051-035	

INDEX BY PART NUMBER

Part #	Page	Part #	Page	Part #	Page	Part #	Page	Part #	Page
1200-001	A-27	1600-002NS	A-41	1600-645T	A-41	1601-764	A-42	1628-509T	A-42
1200-003	A-27	1600-003NS	A-41	1600-654	A-41	1601-964	A-42	1628-609	A-42
1200-005	A-27	1600-004NS	A-41	1600-654T	A-41	1604-128	A-41	1628-609T	A-42
1200-006	A-27	1600-009NS	A-41	1600-662	A-41	1604-135	A-41	1628-709	A-42
1200-007	A-27	1600-010NS	A-41	1600-662T	A-41	1604-145	A-41	1628-709T	A-42
1200-008	A-27	1600-011NS	A-41	1600-935	A-41	1604-154	A-41	1632-109	A-42
1200-009	A-27	1600-012NS	A-41	1600-935T	A-41	1604-162	A-41	1632-109T	A-42
1200-010	A-27	1600-012NS	A-44	1600-945	A-41	1620-109	A-42	1632-509	A-42
1200-011	A-27	1600-013NS	A-41	1600-945T	A-41	1620-109T	A-42	1632-509T	A-42
1200-012	A-27	1600-020	A-41	1600-954	A-41	1620-509	A-42	1632-609	A-42
1200-013	A-28	1600-021	A-41	1600-954T	A-41	1620-509T	A-42	1632-609T	A-42
1200-014	A-28	1600-022	A-41	1600-962	A-41	1620-609	A-42	1632-709	A-42
1200-017	A-28	1600-023	A-41	1600-962T	A-41	1620-609T	A-42	1632-709T	A-42
1200-018	A-28	1600-428	A-41	1600-9355	A-41	1620-709	A-42	1636-109	A-42
1200-019	A-28	1600-435	A-41	1600-9455	A-41	1620-709T	A-42	1636-109T	A-42
1200-019A	A-28	1600-435T	A-41	1600-9545	A-41	1624-109	A-42	1636-509	A-42
1200-038	A-28	1600-445	A-41	1600-9625	A-41	1624-109T	A-42	1636-509T	A-42
1400-001	A-29	1600-445T	A-41	1601-028	A-42	1624-509	A-42	1636-609	A-42
1400-002	A-29	1600-454	A-41	1601-035	A-42	1624-509T	A-42	1636-609T	A-42
1400-003	A-29	1600-454T	A-41	1601-045	A-42	1624-609	A-42	1636-709	A-42
1400-004	A-29	1600-462	A-41	1601-062	A-42	1624-609T	A-42	1636-709T	A-42
1400-005	A-29	1600-462T	A-41	1601-180	A-42	1624-709	A-42	1640-109	A-42
1400-006	A-29	1600-628	A-41	1601-316	A-42	1624-709T	A-42	1640-109T	A-42
1400-011	A-40	1600-635	A-41	1601-332	A-42	1628-109	A-42	1640-509	A-42
1400-013	A-40	1600-635T	A-41	1601-532	A-42	1628-109T	A-42	1640-509T	A-42
1600-001NS	A-41	1600-645	A-41	1601-564	A-42	1628-509	A-42	1640-609	A-42

Part #	Page	Part #	Page	Part #	Page	Part #	Page	Part #	Page
1640-609T	A-42	8051-035	A-44	MS-122	A-28	ZB-122	A-34	ZB-190	A-35
1640-709	A-42	8051-120	A-44	MS-123	A-28	ZB-124	A-34	ZB-192	A-35
1640-709T	A-42	8051-127	A-44	MS-124	A-29	ZB-125	A-34	ZB-200	A-36
1648-109	A-42	8054-010	A-43	MS-125	A-29	ZB-126	A-34	ZB-203	A-36
1648-109T	A-42	8054-011	A-43	MS-131	A-29	ZB-128	A-34	ZB-204	A-36
1648-509	A-42	8054-012	A-43	MS-132	A-29	ZB-130	A-34	ZB-206	A-36
1648-509T	A-42	8054-013	A-43	MS-134	A-29	ZB-132	A-34	ZB-214	A-36
1648-609	A-42	8054-014	A-43	XZS-038	A-21	ZB-136	A-34	ZB-220	A-36
1648-609T	A-42	8054-015	A-43	XZS-338	A-24	ZB-138	A-34	ZB-222	A-36
1648-709	A-42	8054-016	A-43	ZB-70	A-37	ZB-142	A-35	ZB-224	A-36
1648-709T	A-42	8054-017	A-43	ZB-71	A-37	ZB-143	A-35	ZB-226	A-36
1700-001	A-15	8054-018	A-43	ZB-72	A-37	ZB-144	A-35	ZB-228	A-36
1700-002	A-15	8054-019	A-43	ZB-73	A-37	ZB-145	A-35	ZB-230	A-36
1700-003	A-15	8054-020	A-43	ZB-74	A-37	ZB-147	A-35	ZB-232	A-36
1700-007	A-15	8054-021	A-43	ZB-75	A-37	ZB-148	A-35	ZB-236	A-36
1700-008	A-15	8054-022	A-43	ZB-76	A-37	ZB-149	A-35	ZB-238	A-36
1700-009	A-15	8054-023	A-43	ZB-77	A-37	ZB-152	A-35	ZB-252	A-36
1700-010	A-15	8054-024	A-43	ZB-78	A-37	ZB-154	A-35	ZB-254	A-36
1700-012	A-15	MO-121	A-12	ZB-100	A-34	ZB-160	A-35	ZB-260	A-36
1700-013	A-15	MO-122	A-12	ZB-101	A-34	ZB-162	A-35	ZB-262	A-36
8051-011	A-44	MO-123	A-12	ZB-102	A-34	ZB-164	A-35	ZB-264	A-36
8051-013	A-44	MO-124	A-13	ZB-103	A-34	ZB-168	A-35	ZB-266	A-36
8051-015	A-44	MO-125	A-13	ZB-104	A-34	ZB-170	A-35	ZB-268	A-36
8051-018	A-44	MO-126	A-13	ZB-106	A-34	ZB-180	A-35	ZB-270	A-36
8051-020	A-44	MO-127	A-13	ZB-112	A-34	ZB-181	A-35	ZB-292	A-36
8051-021	A-44	MO-128	A-13	ZB-113	A-34	ZB-182	A-35	ZB-306	A-37
8051-027	A-44	MO-129	A-13	ZB-114	A-34	ZB-183	A-35	ZB-322	A-37
8051-032	A-44	MS-121	A-28	ZB-121	A-34	ZB-184	A-35	ZB-324	A-37

Part #	Page	Part #	Page	Part #	Page	Part #	Page	Part #	Page
ZB-326	A-37	ZB-647	A-38	ZO-067	A-16	ZO-7166	A-7	ZO-7596	A-11
ZB-328	A-37	ZB-648	A-38	ZO-068	A-16	ZO-7167	A-7	ZO-7651	A-11
ZB-330	A-37	ZB-650	A-39	ZO-069	A-16	ZO-7172	A-7	ZO-7654	A-11
ZB-336	A-37	ZB-659	A-39	ZO-070	A-17	ZO-7180	A-8	ZO-7682	A-11
ZB-338	A-37	ZB-662	A-39	ZO-071	A-17	ZO-7201	A-8	ZO-7685	A-11
ZB-360	A-37	ZB-664	A-39	ZO-072	A-17	ZO-7205	A-8	ZO-7689	A-12
ZB-362	A-37	ZO11-089-090	A-3	ZO-073	A-17	ZO-7216	A-8	ZO-7718	A-12
ZB-364	A-37	ZO11-119-090	A-3	ZO-076	A-17	ZO-7225	A-33	ZO-72222	A-3
ZB-366	A-37	ZO11-127-090	A-3	ZO-077	A-17	ZO-7226	A-33	ZO-72622	A-3
ZB-447	A-35	ZO18-089-090	A-3	ZO-079	A-31	ZO-7240	A-8	ZO-72623	A-3
ZB-448	A-35	ZO18-127-090	A-3	ZO-165	A-17	ZO-7241	A-8	ZO-72625	A-3
ZB-449	A-35	ZO18-127-100	A-3	ZO-640	A-5	ZO-7242	A-8	ZO-72689	A-4
ZB-582	A-38	ZO18-135-090	A-3	ZO-7050	A-5	ZO-7243	A-9	ZO-72709	A-4
ZB-584	A-38	ZO25-089-075	A-3	ZO-7052	A-5	ZO-7244	A-9	ZO-72719	A-4
ZB-585	A-38	ZO25-089-090	A-3	ZO-7053	A-6	ZO-7245	A-9	ZO-72730	A-4
ZB-586	A-38	ZO25-107-090	A-3	ZO-7055	A-6	ZO-7246	A-9	ZO-72737	A-4
ZB-617	A-38	ZO25-119-090	A-3	ZO-7079	A-32	ZO-7250	A-9	ZO-73416	A-4
ZB-618	A-38	ZO25-127-090	A-3	ZO-7111	A-6	ZO-7251	A-9	ZO-73417	A-4
ZB-619	A-38	ZO25-127-100	A-3	ZO-7123	A-6	ZO-7274	A-9	ZO-73418	A-4
ZB-625	A-38	ZO25-135-090	A-3	ZO-7125	A-32	ZO-7277	A-10	ZO-73419	A-4
ZB-626	A-38	ZO25-147-090	A-3	ZO-7137	A-32	ZO-7278	A-10	ZO-73420	A-5
ZB-627	A-38	ZO-060	A-16	ZO-7145	A-6	ZO-7302	A-10	ZO-73421	A-5
ZB-628	A-38	ZO-061	A-16	ZO-7151	A-6	ZO-7305	A-10	ZO-73422	A-5
ZB-640	A-39	ZO-062	A-16	ZO-7154	A-7	ZO-7309	A-10	ZO-73489	A-5
ZB-642	A-39	ZO-063	A-16	ZO-7156	A-7	ZO-7377	A-10	ZO-73613	A-5
ZB-644	A-39	ZO-064	A-16	ZO-7161	A-7	ZO-7380	A-10	ZO-73616	A-5
ZB-645	A-39	ZO-065	A-16	ZO-7163	A-7	ZO-7390	A-11	ZR-020	A-30
ZB-646	A-39	ZO-066	A-16	ZO-7165	A-7	ZO-7595	A-11	ZR-021	A-30

Part #	Page	Part #	Page	Part #	Page	Part #	Page
ZR-031	A-31	ZS-029	A-20	ZS-327	A-23	ZS-373	A-19
ZR-032	A-31	ZS-030	A-20	ZS-329	A-23	ZS-382	A-26
ZR-032M	A-31	ZS-031	A-20	ZS-330	A-23	ZS-390	A-26
ZR-033M	A-31	ZS-032	A-21	ZS-331	A-23	ZS-395	A-26
ZR-050	A-30	ZS-033	A-21	ZS-332	A-23	ZS-410	A-25
ZR-051	A-30	ZS-034	A-21	ZS-333	A-23	ZS-412	A-26
ZR-052	A-30	ZS-035	A-21	ZS-334	A-24	ZS-414	A-26
ZR-053	A-30	ZS-036	A-21	ZS-336	A-24	ZS-510	A-26
ZR-058	A-14	ZS-037	A-21	ZS-337	A-24		
ZR-059	A-14	ZS-038	A-21	ZS-338	A-24		
ZR-060	A-14	ZS-038A	A-21	ZS-339	A-24		
ZR-061	A-14	ZS-039	A-22	ZS-340	A-24		
ZR-073	A-14	ZS-040	A-22	ZS-341	A-24		
ZR-079	A-14	ZS-041	A-22	ZS-342	A-24		
ZR-080	A-40	ZS-042	A-22	ZS-343	A-25		
ZR-081	A-40	ZS-043	A-22	ZS-360	A-18		
ZR-082	A-40	ZS-103	A-25	ZS-361	A-18		
ZR-083	A-40	ZS-104	A-22	ZS-362	A-18		
ZR-084	A-40	ZS-105	A-25	ZS-363	A-18		
ZR-085	A-40	ZS-110	A-26	ZS-364	A-18		
ZR-120	A-30	ZS-114	A-25	ZS-365	A-18		
ZR-154	A-30	ZS-115	A-25	ZS-366	A-18		
ZR-160	A-14	ZS-125	A-25	ZS-367	A-18		
ZR-733	A-30	ZS-128	A-22	ZS-368	A-18		
ZS-015	A-20	ZS-129	A-22	ZS-369	A-18		
ZS-018	A-20	ZS-225	A-25	ZS-370	A-19		
ZS-027	A-20	ZS-304	A-23	ZS-371	A-19		
ZS-028	A-20	ZS-318	A-23	ZS-372	A-19		

BRASSELER-STYLE BLADES, BURS + RASPS

Brasseler	MicroAire	Page	Brasseler	MicroAire	Page	Brasseler	MicroAire	Page
03-C0312	ZB-154	A-35	04-C0609	ZB-102	A-34	09-D0132	ZB-264	A-36
03-C0901	ZB-136	A-34	04-C0612	ZB-113	A-34	09-D0135	ZB-266	A-36
03-C0905	ZB-138	A-34	04-C0612	ZB-75	A-37	09-D0138	ZB-270	A-36
03-D0135	ZB-164	A-35	04-C0615	ZB-74	A-37	09-D0139	ZB-262	A-36
03-D0138	ZB-168	A-35	04-C0617	ZB-106	A-34	09-D0141	ZB-268	A-36
03-D0911	ZB-170	A-35	04-C1803	ZB-190	A-35	09-D0911	ZB-306	A-37
03-D1901	ZB-180	A-35	04-D0139	ZB-160	A-35	10-C0101	ZB-222	A-36
03-D1902	ZB-181	A-35	04-D1903	ZB-182	A-35	10-C0103	ZB-224	A-36
04-C0101	ZB-121	A-34	04-D2001	ZB-183	A-35	10-C0105	ZB-226	A-36
04-C0103	ZB-122	A-34	04-S1501	ZB-192	A-35	10-C0107	ZB-228	A-36
04-C0104	ZB-76	A-37	04-S1701	ZB-147	A-35	10-C0108	ZB-230	A-36
04-C0105	ZB-124	A-34	04-S1703	ZB-148	A-35	10-C0306	ZB-206	A-36
04-C0106	ZB-71	A-37	04-S1704	ZB-149	A-35	10-C0310	ZB-254	A-36
04-C0107	ZB-126	A-34	06-C0619	ZB-114	A-34	10-C0617	ZB-214	A-36
04-C0108	ZB-128	A-34	06-S1601	ZB-142	A-35	10-D0139	ZB-362	A-37
04-C0109	ZB-130	A-34	07-S1602	ZB-143	A-35	11-C0619	ZB-220	A-36
04-C0170	ZB-132	A-34	07-S1604	ZB-145	A-35	12-C0105	ZB-326	A-37
04-C0302	ZB-101	A-34	07-S1605	ZB-144	A-35	12-C0108	ZB-330	A-37
04-C0303	ZB-78	A-37	08-S1802	ZB-112	A-34	12-C0109	ZB-336	A-37
04-C0306	ZB-104	A-34	09-C0109	ZB-232	A-36	12-C0901	ZB-338	A-37
04-C0307	ZB-72	A-37	09-C0110	ZB-236	A-36	12-C0905	ZB-360	A-37
04-C0310	ZB-152	A-35	09-C0170	ZB-232	A-36	12-D0133	ZB-364	A-37
04-C0404	ZB-77	A-37	09-C0312	ZB-260	A-36	12-D0141	ZB-70	A-37
04-C0602	ZB-100	A-34	09-C0613	ZB-204	A-36	12-S0101	ZB-322	A-37
04-C0604	ZB-103	A-34	09-C0901	ZB-238	A-36	12-S0150	ZB-324	A-37
04-C0606	ZB-73	A-37	09-C0905	ZB-252	A-36	12-S0153	ZB-328	A-37

BRASSELER-STYLE BLADES, BURS + RASPS

Brasseler	MicroAire	Page	Brasseler	MicroAire	Page	Brasseler	MicroAire	Page
14-C0104	K-75	B-40*	16-S0109	K-56	B-39*	19-S1301	K-23	B-38*
14-C0106	K-70	B-40*	16-S0110	K-57	B-39*	19-S1705	K-19	B-37*
14-C0308	K-71	B-40*	16-S0111	K-60	B-40*	19-S1802	K-22	B-38*
14-C0606	K-72	B-40*	16-S0113	K-62	B-40*	70-C0108	ZB-619	A-38
14-C0608	K-73	B-40*	16-S0115	K-10	B-37*	70-C0109	ZB-618	A-38
14-C0616	K-74	B-40*	16-S0116	K-64	B-40*	70-C0170	ZB-617	A-38
14-C0702	K-76	B-40*	16-S0117	K-11	B-37*	71-C0107	ZB-628	A-38
14-S0124	K-14	B-37*	16-S0118	K-65	B-40*	71-C0108	ZB-627	A-38
14-S0125	K-15	B-37*	16-S0119	K-52	B-39*	71-C0109	ZB-626	A-38
14-S0127	K-05	B-37*	16-S0120	K-12	B-37*	71-C0170	ZB-625	A-38
14-S0402	K-01	B-37*	16-S0121	K-54	B-39*	71-D0135	ZB-648	A-38
14-S0903	K-02	B-37*	16-S0122	K-55	B-39*	71-D0141	ZB-647	A-38
14-S0909	K-03	B-37*	16-S0123	K-13	B-37*	72-C0107	ZB-646	A-39
14-S1201	K-04	B-37*	16-S0124	K-36	B-38*	72-C0108	ZB-645	A-39
15-S1101	K-08	B-37*	16-S0126	K-58	B-39*	72-C0109	ZB-644	A-39
16-D0128	K-40	B-39*	16-S0402	K-33	B-38*	72-D0133	ZB-659	A-39
16-D0129	K-41	B-39*	16-S0621	K-20	B-38*	72-D0141	ZB-650	A-39
16-D0130	K-42	B-39*	16-S0903	K-38	B-38*	75-D0139	ZB-662	A-39
16-D0131	K-43	B-39*	16-S0909	K-34	B-38*	75-S0101	ZB-664	A-39
16-D0132	K-44	B-39*	16-S1201	K-35	B-38*	75-S0150	ZB-640	A-39
16-D0134	K-45	B-39*	16-S1601	K-26	B-38*	75-S0151	ZB-642	A-39
16-D0135	K-46	B-39*	16-S1702	K-17	B-37*	B60-1190-35	SO11-089-090	B-13*
16-D0136	K-47	B-39*	16-S1801	K-21	B-38*	B60-1190-50	SO11-127-090	B-13*
16-D0137	K-48	B-39*	17-S1602	K-27	B-38*	B60-1890-35	SO18-089-090	B-13*
16-S0103	K-09	B-37*	17-S1603	K-28	B-38*	B60-1890-50	SO18-127-090	B-13*
16-S0106	K-50	B-39*	18-S1701	K-16	B-37*	B60-1890-53	SO18-135-090	B-13*
16-S0107	K-51	B-39*	18-S1703	K-18	B-37*	B60-25100-50	SO25-127-100	B-13*
16-S0108	K-53	B-39*	19-S0801	K-25	B-38*	B60-2575-35	SO25-089-075	B-14*

* Download catalog section B to view product page at www.microaire.com

BRASSELER-STYLE BLADES, BURS + RASPS

Brasseler	MicroAire	Page	Brasseler	MicroAire	Page	Brasseler	MicroAire	Page
B60-2590-35	SO25-089-090	B-14*	KM-104	ZS-104	A-22	KM-17002	1700-002	A-15
B60-2590-50	SO25-119-090	B-14*	KM-105	ZS-015	A-20	KM-17003	1700-003	A-15
B60-2590-53	SO25-135-090	B-14*	KM-106	ZS-032	A-21	KM-17007	1700-007	A-15
K121	MS-121	A-28	KM-107	ZS-041	A-22	KM-17008	1700-008	A-15
K122	MS-122	A-28	KM-108	ZS-042	A-22	KM-17009	1700-009	A-15
K123	MS-123	A-28	KM-109	ZS-043	A-22	KM-17010	1700-010	A-15
K124	MS-124	A-29	KM-109C	ZS-030	A-20	KM-17012	1700-012	A-15
K125	MS-125	A-29	KM-12001	1200-001	A-27	KM-17013	1700-013	A-15
K131	MS-131	A-29	KM-12005	1200-005	A-27	KM-218	ZS-018	A-20
K132	MS-132	A-29	KM-12006	1200-006	A-27	KM-21L	MO-121	A-12
K134	MS-134	A-29	KM-12007	1200-007	A-27	KM22L	MO-122	A-12
K-2000-61	SO-677	B-20*	KM-12008	1200-008	A-27	KM-231	ZS-031	A-20
K-2000-65J	SO-699	B-21*	KM-12009	1200-009	A-27	KM-234	ZS-034	A-21
K-2000-65T	SO-676	B-20*	KM-12010	1200-010	A-27	KM-235	ZS-035	A-21
K-2000-69	SO-683	B-20*	KM-12011	1200-011	A-27	KM-237	ZS-037	A-21
KM-000	ZO-062	A-16	KM-12012	1200-012	A-27	KM-23L	MO-123	A-12
KM-001	ZO-064	A-16	KM-12013	1200-013	A-28	KM-240	ZS-040	A-22
KM-002	ZO-073	A-17	KM-12014	1200-014	A-28	KM-24L	MO-124	A-13
KM-004	ZO-065	A-16	KM-12017	1200-017	A-28	KM-250R	SR-250	B-22*
KM-005	ZO-063	A-16	KM-12018	1200-018	A-28	KM-25L	MO-125	A-13
KM-006	ZO-060	A-16	KM-12019	1200-019	A-28	KM-261	ZO-061	A-16
KM-008	ZO-066	A-16	KM-14001	1400-001	A-29	KM-267	ZO-067	A-16
KM-060	ZR-020	A-30	KM-14002	1400-002	A-29	KM-268	ZO-068	A-16
KM-070	ZR-021	A-30	KM-14003	1400-003	A-29	KM-269	ZO-069	A-16
KM-100C	ZS-033	A-31	KM-14004	1400-004	A-29	KM-26L	MO-126	A-13
KM-101	ZS-038	A-21	KM-14005	1400-005	A-29	KM-275R	SR-275	B-22*
KM-101C	ZS-038A	A-21	KM-14006	1400-006	A-29	KM-277	SR-027	B-36*
KM-102	ZS-039	A-22	KM-17001	1700-001	A-15	KM-279	ZO-079	A-31

* Download catalog section B to view product page at www.microaire.com

BRASSELER-STYLE BLADES, BURS + RASPS

Brasseler	MicroAire	Page	Brasseler	MicroAire	Page	Brasseler	MicroAire	Page
KM-27L	MO-127	A-13	KM3-115	SP-115	B-26*	KM33-125	SP-125A	B-27*
KM-28L	MO-128	A-13	KM3-125	SP-125	B-27*	KM33-206	SP-206A	B-28*
KM-29L	MO-129	A-13	KM-3170	ZS-370	A-19	KM33-212	SP-212A	B-28*
KM-3000	ZS-362	A-18	KM-3171	ZS-371	A-19	KM33-225	SP-225A	B-28*
KM-3001	ZS-364	A-18	KM-3172	ZS-372	A-19	KM33-410	SP-410A	B-29*
KM-3002	ZS-369	A-18	KM-3173	ZS-373	A-19	KM33-411	SP-411A	B-30*
KM-3005	ZS-363	A-18	KM-32	ZR-032	A-31	KM33-412	SP-412A	B-30*
KM-3006	ZS-360	A-18	KM3-206	SP-206	B-27*	KM33-413	SP-413A	B-30*
KM-3008	ZS-366	A-18	KM3-212	SP-212	B-28*	KM33-414	SP-414A	B-30*
KM-300R	SR-300	B-22*	KM-3218	ZS-318	A-23	KM3-410	SP-410	B-29*
KM31	ZR-031	A-31	KM3-225	SP-225	B-28*	KM3-411	SP-411	B-29*
KM-3100C	ZS-333	A-23	KM-3229	ZS-329	A-23	KM3-412	SP-412	B-30*
KM-3101	ZS-338	A-24	KM-3231	ZS-331	A-23	KM3-413	SP-413	B-30*
KM3-101	SP-101	B-25*	KM-3237	ZS-337	A-24	KM3-414	SP-414	B-30*
KM-3101C	ZS-343	A-25	KM-3240	ZS-340	A-24	KM410S	SO-410	B-23*
KM-3102	ZS-339	A-24	KM-325R	SR-325	B-22*	KM-411S	SO-411	B-23*
KM3-102	SP-102	B-25*	KM-3261	ZS-361	A-18	KM-412S	SO-412	B-23*
KM3-103	SP-103	B-25*	KM-3265	ZS-365	A-18	KM-413S	SO-413	B-23*
KM3-104	SP-104	B-25*	KM33-101	SP-101A	B-25*	KM-414S	SO-414	B-23*
KM3-105	SP-105	B-25*	KM33-102	SP-102A	B-25*	KM-415S	SO-415	B-24*
KM-3106	ZS-332	A-23	KM33-103	SP-103A	B-25*	KM-416S	SO-416	B-24*
KM3-106	SP-106	B-26*	KM33-104	SP-104A	B-25*	KM-417S	SO-417	B-24*
KM-3107	ZS-341	A-24	KM33-105	SP-105A	B-26*	KM-458	ZR-058	A-14
KM-3108	ZS-342	A-24	KM33-106	SP-106A	B-26*	KM-459	ZR-059	A-14
KM3-108	SP-108	B-26*	KM33-108	SP-108A	B-26*	KM-460	ZR-060	A-14
KM-3109C	ZS-330	A-23	KM33-111	SP-111A	B-26*	KM-461	ZR-061	A-14
KM3-111	SP-111	B-26*	KM33-114	SP-114A	B-26*	KM-473	ZR-073	A-14
KM3-114	SP-114	B-26*	KM33-115	SP-115A	B-27*	KM-479	ZR-079	A-14

* Download catalog section B to view product page at www.microaire.com

BRASSELER-STYLE BLADES, BURS + RASPS

Brasseler	MicroAire	Page	Brasseler	MicroAire	Page	Brasseler	MicroAire	Page
KM-50	ZR-050	A-30	KM-656	SO-656	B-19*	KM71-586	ZO-7165	A-7
KM-51	ZR-051	A-30	KM-658	SO-658	B-19*	KM71-588	ZO-7278	A-10
KM5100-137-115	SR-51-080	B-42*	KM-660	SO-660	B-19*	KM71-595	ZO-7595	A-11
KM5100-137-123	SR-51-723	B-33*	KM-675	SO-675	B-19*	KM71-596	ZO-7596	A-11
KM5100-137-133	SR-51-733	B-33*	KM-683	SO-682	B-20*	KM-72	ZO-072	A-17
KM5100-137-233	SR-51-007	B-32*	KM-689	SO-685	B-20*	KM-7201	ZO-7201	A-8
KM5100-37-113	SR-51-082	B-42*	KM-693	SO-689	B-20*	KM-7567	ZO-7167	A-7
KM5100-37-114	SR-51-083	B-42*	KM-70	ZO-070	A-17	KM-7572	ZO-7172	A-7
KM5100-37-116	SR-51-081	B-42*	KM-71	ZO-071	A-17	KM-80	ZR-080	A-40
KM-52	ZR-052	A-30	KM71-523	ZO-7123	A-6	KM-801	SR-080	B-41*
KM-53	ZR-053	A-30	KM71-540	ZO-7240	A-8	KM-802	SR-083	B-41*
KM-600	SO-600	B-15*	KM71-542	ZO-7242	A-8	KM-81	ZR-081	A-40
KM-602	SO-602	B-15*	KM71-543	ZO-7243	A-9	KM-82	ZR-082	A-40
KM-605	SO-605	B-15*	KM71-544	ZO-7244	A-9	KM-83	ZR-083	A-40
KM-609	SO-609	B-15*	KM71-545	ZO-7245	A-9	KM-97	SR-100	B-36*
KM-610	SO-610	B-16*	KM71-550	ZO-7050	A-9	KM-98	SR-101	B-36*
KM-611	SO-611	B-16*	KM71-551	ZO-7151	A-6	ST2108-100	SO6-100	B-3*
KM-615	SO-615	B-16*	KM71-552	ZO-7052	A-5	ST2108-102	SO6-102	B-3*
KM-618	SO-618	B-16*	KM71-553	ZO-7053	A-6	ST2108-103	SO6-103	B-3*
KM-619	SO-718	B-21*	KM71-554	ZO-7154	A-7	ST2108-105	SO6-105	B-3*
KM-620	SO-620	B-16*	KM71-555	ZO-7055	A-6	ST2108-109	SO6-109	B-3*
KM-625	SO-625	B-35*	KM71-556	ZO-7156	A-7	ST2108-110	SO6-110	B-4*
KM-640	SO-640	B-18*	KM71-561	ZO-7161	A-7	ST2108-111	SO6-111	B-4*
KM-645	SO-645	B-18*	KM71-563	ZO-7163	A-7	ST2108-113	SO6-113	B-4*
KM-648	SO-648	B-18*	KM71-566	ZO-7166	A-7	ST2108-115	SO6-115	B-4*
KM-650	SO-650	B-18*	KM71-574	ZO-7274	A-9	ST2108-118	SO6-118	B-4*
KM-651	SO-651	B-18*	KM71-577	ZO-7277	A-10	ST2108-120	SO6-120	B-4*
KM-655	SO-655	B-19*	KM71-580	ZO-7180	A-8	ST2108-125	SO6-125	B-34*

* Download catalog section B to view product page at www.microaire.com

BRASSELER-STYLE BLADES, BURS + RASPS

Brasseler	MicroAire	Page	Brasseler	MicroAire	Page
ST2108-131	SO6-131	B-4*	ST4118-127-100	SO618-127-100	B-11*
ST2108-140	SO6-140	B-4*	ST4118-137-090	SO618-135-090	B-11*
ST2108-144	SO6-144	B-5*	ST4125-064-075	SO625-064-075	B-11*
ST2108-145	SO6-145	B-5*	ST4125-089-090	SO625-089-075	B-11*
ST2108-148	SO6-148	B-5*	ST4125-127-090	SO625-127-090	B-12*
ST2108-150	SO6-150	B-5*	ST4125-127-100	SO625-127-100	B-12*
ST2108-151	SO6-151	B-5*	ST4125-135-090	SO625-135-090	B-12*
ST2108-152	SO6-152	B-5*	ST4125-147-090	SO625-147-090	B-12*
ST2108-155	SO6-155	B-5*			
ST2108-156	SO6-156	B-6*			
ST2108-158	SO6-158	B-6*			
ST2108-160	SO6-160	B-6*			
ST2108-175	SO6-175	B-6*			
ST2108-176	SO6-176	B-6*			
ST2108-177	SO6-177	B-6*			
ST2108-182	SO6-182	B-7*			
ST2108-183	SO6-183	B-7*			
ST2108-185	SO6-185	B-7*			
ST2108-189	SO6-189	B-7*			
ST2108-193	SO6-193	B-7*			
ST2108-195	SO6-195	B-8*			
ST2108-197	SO6-197	B-8*			
ST2108-218	SO6-218	B-8*			
ST4111-127-090	SO611-127-090	B-10*			
ST4111-147-090	SO611-147-075	B-10*			
ST4118-089-075	SO618-089-075	B-11*			
ST4118-119-090	SO618-119-090	B-11*			
ST4118-127-090	SO618-127-075	B-11*			

* Download catalog section B to view product page at www.microaire.com

BRASSELER-STYLE DRILLS, PINS + WIRES

Brasseler	MicroAire	Page	Brasseler	MicroAire	Page	Brasseler	MicroAire	Page
KM166-00-00	8054-010NS	A-43	KM168-19-31	1648-509NS	A-42	KM169-19-96	1636-509TNS	A-42
KM166-00-01	8054-011NS	A-43	KM168-19-33	1624-509NS	A-42	KM169-29-18	1632-109TNS	A-42
KM166-00-02	8054-012NS	A-43	KM168-19-53	1640-509NS	A-42	KM169-29-31	1648-109TNS	A-42
KM166-00-03	8054-013NS	A-43	KM168-19-56	1620-509NS	A-42	KM169-29-33	1624-109TNS	A-42
KM166-00-04	8054-014NS	A-43	KM168-19-76	1628-509NS	A-42	KM169-29-53	1640-109TNS	A-42
KM166-00-05	8054-015NS	A-43	KM168-19-96	1636-509NS	A-42	KM169-29-56	1620-109TNS	A-42
KM166-00-06	8054-016NS	A-43	KM168-29-18	1632-109NS	A-42	KM169-29-76	1628-109TNS	A-42
KM166-00-07	8054-018NS	A-43	KM168-29-31	1648-109NS	A-42	KM169-29-96	1636-109TNS	A-42
KM166-00-08	8054-019NS	A-43	KM168-29-33	1624-109NS	A-42	KM169-39-18	1632-609TNS	A-42
KM166-310-11	8053-011NS	C-4*	KM168-29-53	1640-109NS	A-42	KM169-39-31	1648-609TNS	A-42
KM166-310-15	8053-015NS	C-4*	KM168-29-56	1620-109NS	A-42	KM169-39-33	1624-609TNS	A-42
KM166-310-16	8053-016NS	C-4*	KM168-29-76	1628-109NS	A-42	KM169-39-53	1640-609TNS	A-42
KM166-310-19	8053-019NS	C-4*	KM168-29-96	1636-109NS	A-42	KM-169-39-56	1620-609TNS	A-42
KM166-310-21	8053-021NS	C-4*	KM168-39-18	1632-609NS	A-42	KM169-39-76	1628-609TNS	A-42
KM166-310-23	8053-023NS	C-4*	KM168-39-31	1648-609NS	A-42	KM169-39-96	1636-609TNS	A-42
KM166-310-25	8053-025NS	C-4*	KM168-39-33	1624-609NS	A-42	KM-172-155-28	1600-020NS	A-41
KM166-310-26	8053-026NS	C-4*	KM168-39-53	1640-609NS	A-42	KM-172-155-35	1600-021NS	A-41
KM166-310-28	8053-028NS	C-4*	KM168-39-56	1620-609NS	A-42	KM-172-155-45	1600-022NS	A-41
KM166-310-29	8053-029NS	C-4*	KM168-39-76	1628-609NS	A-42	KM-172-155-62	1600-023NS	A-41
KM166-310-31	8053-031NS	C-4*	KM168-39-96	1636-609NS	A-42	KM-172-19-35	1600-9355NS	A-41
KM166-310-35	8053-035NS	C-4*	KM169-19-18	1632-509TNS	A-42	KM-172-19-45	1600-9455NS	A-41
KM166-310-37	8053-037NS	C-4*	KM169-19-31	1648-509TNS	A-42	KM-172-19-54	1600-9545NS	A-41
KM166-310-44	8053-044NS	C-4*	KM169-19-33	1624-509TNS	A-42	KM-172-19-62	1600-9625NS	A-41
KM166-310-48	8053-048NS	C-4*	KM169-19-53	1640-509TNS	A-42	KM-172-24-28	1600-428NS	A-41
KM166-310-60	8053-060NS	C-4*	KM169-19-56	1620-509TNS	A-42	KM-172-24-35	1600-435NS	A-41
KM168-19-18	1632-509NS	A-42	KM169-19-76	1628-509TNS	A-42	KM-172-24-45	1600-445NS	A-41

* Download catalog section C to view product page at www.microaire.com

BRASSELER-STYLE DRILLS, PINS + WIRES

Brasseler	MicroAire	Page
KM-172-24-54	1600-454NS	A-41
KM-172-24-62	1600-462NS	A-41
KM-172-26-28	1600-628NS	A-41
KM-172-26-35	1600-635NS	A-41
KM-172-26-45	1600-645NS	A-41
KM-172-26-54	1600-654NS	A-41
KM-172-26-62	1600-662NS	A-41
KM-172-29-35	1600-935NS	A-41
KM-172-29-45	1600-945NS	A-41
KM-172-29-54	1600-954NS	A-41
KM-172-29-62	1600-962NS	A-41
KM-173-29-35	1600-935TNS	A-41
KM-173-29-45	1600-945TNS	A-41
KM-173-29-54	1600-954TNS	A-41
KM-173-29-62	1600-962TNS	A-41

LINVATEC-STYLE BLADES, BURS + RASPS

Linvatec	MicroAire	Page	Linvatec	MicroAire	Page	Linvatec	MicroAire	Page
1384-77	ZO-077	A-17	5023-171	ZS-371	A-19	5053-037/237	ZS-037	A-21
5021-163	ZS-363	A-18	5023-172	ZS-372	A-19	5053-038/238	ZS-038	A-21
5023-118	ZS-318	A-23	5023-173	ZS-373	A-19	5053-039/239	ZS-039	A-22
5023-129	ZS-329	A-23	5023-179	ZO-079	A-31	5053-040/240	ZS-040	A-22
5023-130	ZS-330	A-23	5052-173	ZR-073	A-14	5053-041/241	ZS-041	A-22
5023-131	ZS-331	A-23	5052-179	ZR-079	A-14	5053-042/242	ZS-042	A-22
5023-132	ZS-332	A-23	5052-182	ZB-582	A-38	5053-050	ZR-050	A-30
5023-133	ZS-333	A-23	5052-184	ZB-584	A-38	5053-051	ZR-051	A-30
5023-134	ZS-334	A-24	5052-185	ZB-585	A-38	5053-052	ZR-052	A-30
5023-136	ZS-336	A-24	5052-186	ZB-586	A-38	5053-053	ZR-053	A-30
5023-137	ZS-337	A-24	5052-258	ZR-058	A-14	5053-054	ZR-154	A-30
5023-138	ZS-338	A-24	5052-259	ZR-059	A-14	5053-060/260	ZO-060	A-16
5023-139	ZS-339	A-24	5052-260	ZR-160	A-14	5053-061/261	ZO-061	A-16
5023-140	ZS-340	A-24	5052-261	ZR-060	A-14	5053-062/262	ZO-062	A-16
5023-141	ZS-341	A-24	5052-261	ZR-061	A-14	5053-063/263	ZO-063	A-16
5023-142	ZS-342	A-24	5052-279	ZR-079	A-14	5053-064/264	ZO-064	A-16
5023-143	ZS-343	A-25	5053-018/218	ZS-018	A-20	5053-067/267	ZO-067	A-16
5023-160	ZS-360	A-18	5053-028/228	ZS-128	A-22	5053-069/269	ZO-069	A-16
5023-161	ZS-361	A-18	5053-029/229	ZS-129	A-22	5053-073/273	ZO-073	A-17
5023-162	ZS-362	A-18	5053-030/230	ZS-030	A-20	5053-170	ZO-070	A-17
5023-163	ZS-363	A-18	5053-031/231	ZS-031	A-20	5053-171	ZO-071	A-17
5023-164	ZS-364	A-18	5053-032/232	ZS-032	A-21	5053-172	ZO-072	A-17
5023-165	ZS-365	A-18	5053-033/233	ZS-033	A-21	5053-220	ZR-020	A-30
5023-166	ZS-366	A-18	5053-034/234	ZS-034	A-21	5053-220	ZR-120	A-30
5023-169	ZS-369	A-18	5053-035/235	ZS-035	A-21	5053-221	ZR-021	A-30
5023-170	ZS-370	A-19	5053-036/236	ZS-036	A-21	5053-80	ZR-080	A-40

LINVATEC-STYLE BLADES, BURS + RASPS

Linvatec	MicroAire	Page	Linvatec	MicroAire	Page	Linvatec	MicroAire	Page
5053-81	ZR-081	A-40	5071-140	ZO-7240	A-8	5071-572	ZO-7172	A-7
5053-82	ZR-082	A-40	5071-141	ZO-7241	A-8	5091-080	ZB-180	A-35
5053-83	ZR-083	A-40	5071-142	ZO-7242	A-8	5091-081	ZB-181	A-35
5053-84	ZR-084	A-40	5071-143	ZO-7243	A-9	5091-082	ZB-182	A-35
5056-117	ZB-617	A-38	5071-144	ZO-7244	A-9	5091-083	ZB-183	A-35
5056-118	ZB-618	A-38	5071-145	ZO-7245	A-9	5091-201	ZB-101	A-34
5056-119	ZB-619	A-38	5071-146	ZO-7246	A-9	5091-202	ZB-102	A-34
5056-125	ZB-625	A-38	5071-161	ZO-7161	A-7	5091-204	ZB-104	A-34
5056-126	ZB-626	A-38	5071-163	ZO-7163	A-7	5091-206	ZB-106	A-34
5056-127	ZB-627	A-38	5071-167	ZO-7167	A-7	5091-212	ZB-112	A-34
5056-128	ZB-628	A-38	5071-174	ZO-7274	A-9	5091-214	ZB-114	A-34
5056-140	ZB-640	A-39	5071-180	ZO-7180	A-8	5091-221	ZB-121	A-34
5056-142	ZB-642	A-39	5071-181	ZO-7201	A-8	5091-222	ZB-122	A-34
5056-144	ZB-644	A-39	5071-186	ZO-7165	A-7	5091-224	ZB-124	A-34
5056-145	ZB-645	A-39	5071-186	ZO-7166	A-7	5091-225	ZB-125	A-34
5056-146	ZB-646	A-39	5071-187	ZO-7277	A-10	5091-226	ZB-126	A-34
5056-147	ZB-647	A-38	5071-188	ZO-7278	A-10	5091-228	ZB-128	A-34
5056-148	ZB-648	A-38	5071-195	ZO-7595	A-11	5091-230	ZB-130	A-34
5056-150	ZB-650	A-39	5071-196	ZO-7596	A-11	5091-232	ZB-132	A-34
5056-159	ZB-659	A-39	5071-201	ZO-7201	A-8	5091-236	ZB-136	A-34
5056-162	ZB-662	A-39	5071-530	ZO-7390	A-11	5091-238	ZB-138	A-34
5056-164	ZB-664	A-39	5071-550	ZO-7050	A-5	5091-242	ZB-142	A-35
5059-031	ZR-031	A-31	5071-551	ZO-7151	A-6	5091-243	ZB-143	A-35
5059-031	ZR-032	A-31	5071-552	ZO-7052	A-5	5091-244	ZB-144	A-35
5059-279	ZO-7079	A-32	5071-553	ZO-7053	A-6	5091-245	ZB-145	A-35
5071-123	ZO-7123	A-6	5071-554	ZO-7154	A-7	5091-247	ZB-147	A-35
5071-125	ZO-7225	A-33	5071-555	ZO-7055	A-6	5091-248	ZB-148	A-35
5071-126	ZO-7226	A-33	5071-556	ZO-7156	A-7	5091-249	ZB-149	A-35

LINVATEC-STYLE BLADES, BURS + RASPS

Lintratec	MicroAire	Page	Lintratec	MicroAire	Page	Lintratec	MicroAire	Page
5091-252	ZB-152	A-35	5093-266	ZB-366	A-37	KM-17009	1700-009	A-15
5092-203	ZB-203	A-36	K121	MS-121	A-28	KM-17010	1700-010	A-15
5092-206	ZB-206	A-36	K122	MS-122	A-28	KM-17012	1700-012	A-15
5092-214	ZB-214	A-36	K123	MS-123	A-28	KM-17013	1700-013	A-15
5092-220	ZB-220	A-36	K124	MS-124	A-29	L121	MO-121	A-12
5092-222	ZB-222	A-36	K125	MS-125	A-29	L122	MO-122	A-12
5092-224	ZB-224	A-36	K131	MS-131	A-29	L123	MO-123	A-12
5092-226	ZB-226	A-36	K132	MS-132	A-29	L124	MO-124	A-13
5092-228	ZB-228	A-36	K134	MS-134	A-29	L125	MO-125	A-13
5092-230	ZB-230	A-36	KM-12001	1200-001	A-27	L126	MO-126	A-13
5092-232	ZB-232	A-36	KM-12005	1200-005	A-27	L127	MO-127	A-13
5092-236	ZB-236	A-36	KM-12006	1200-006	A-27	L128	MO-128	A-13
5092-238	ZB-238	A-36	KM-12007	1200-007	A-27	L129	MO-129	A-13
5092-252	ZB-252	A-36	KM-12008	1200-008	A-27	ZR-032M	ZR-032M	A-31
5092-254	ZB-154	A-35	KM-12009	1200-009	A-27	ZR-033M	ZR-033M	A-31
5092-254	ZB-254	A-36	KM-12010	1200-010	A-27	ZS-110	ZS-110	A-26
5092-260	ZB-260	A-36	KM-12011	1200-011	A-27	ZS-304	ZS-304	A-23
5092-264	ZB-264	A-36	KM-12012	1200-012	A-27	ZS-327	ZS-327	A-23
5092-268	ZB-268	A-36	KM-12013	1200-013	A-28	ZS-382	ZS-382	A-26
5092-270	ZB-270	A-36	KM-12014	1200-014	A-28	ZS-390	ZS-390	A-26
5093-222	ZB-322	A-37	KM-12017	1200-017	A-28	ZS-395	ZS-395	A-26
5093-224	ZB-324	A-37	KM-12018	1200-018	A-28	ZS-510	ZS-510	A-26
5093-226	ZB-326	A-37	KM-12019	1200-019	A-28			
5093-228	ZB-328	A-37	KM-17001	1700-001	A-15			
5093-230	ZB-330	A-37	KM-17002	1700-002	A-15			
5093-236	ZB-336	A-37	KM-17003	1700-003	A-15			
5093-238	ZB-338	A-37	KM-17007	1700-007	A-15			
5093-262	ZB-362	A-37	KM-17008	1700-008	A-15			

LINVATEC-STYLE DRILLS, PINS + WIRES

Lintratec	MicroAire	Page	Lintratec	MicroAire	Page	Lintratec	MicroAire	Page
186-04-16	1600-628NS	A-41	187-05-69	1636-609NS	A-42	2410-45	8053-044	C-4*
186-44	1600-635NS	A-41	187-05-79	1636-709NS	A-42	2410-46	8053-048	C-4*
186-46	1600-935NS	A-41	187-06-19	1640-109NS	A-42	2410-600	8053-060	C-4*
186-60	1600-645NS	A-41	187-06-59	1640-509NS	A-42	256-01-21	8054-010	A-43
186-62	1600-945NS	A-41	187-06-69	1640-609NS	A-42	256-01-22	8054-011	A-43
186-66	1600-9455NS	A-41	187-06-79	1640-709NS	A-42	256-01-23	8054-012	A-43
186-76	1600-662NS	A-41	187-07-19	1648-109NS	A-42	256-01-24	8054-013	A-43
186-78	1600-962NS	A-41	187-07-59	1648-509NS	A-42	256-01-25	8054-014	A-43
186-82	1600-9625NS	A-41	187-07-69	1648-609NS	A-42	256-01-26	8054-015	A-43
187-01-19	1620-109NS	A-42	187-07-79	1648-709NS	A-42	256-01-27	8054-016	A-43
187-01-69	1620-609NS	A-42	2318-20	8054-020	A-43	256-01-28	8054-017	A-43
187-01-79	1620-709NS	A-42	2318-27	8054-021	A-43	256-01-29	8054-018	A-43
187-02-19	1624-109NS	A-42	2318-32	8054-022	A-43	2620-01	1636-109TNS	A-42
187-02-59	1624-509NS	A-42	2318-35	8054-023	A-43	2620-03	1628-109TNS	A-42
187-02-69	1624-609NS	A-42	2318-45	8054-024	A-43	262-01-04	1648-609TNS	A-42
187-02-79	1624-709NS	A-42	2410-11	8053-011	C-4*	2620-11	1648-109TNS	A-42
187-03-19	1628-109NS	A-42	2410-15	8053-015	C-4*	2620-13	1648-509TNS	A-42
187-03-59	1628-509NS	A-42	2410-20	8053-019	C-4*	2620-15	1640-109TNS	A-42
187-03-69	1628-609NS	A-42	2410-21	8053-021	C-4*	2620-17	1640-509TNS	A-42
187-03-79	1628-709NS	A-42	2410-25	8053-025	C-4*	262-01-79	1648-709TNS	A-42
187-04-19	1632-109NS	A-42	2410-27	8053-026	C-4*	2620-19	1636-509TNS	A-42
187-04-59	1632-509NS	A-42	2410-28	8053-028	C-4*	262-02-04	1640-609TNS	A-42
187-04-69	1632-609NS	A-42	2410-32	8053-031	C-4*	2620-21	1632-109TNS	A-42
187-04-79	1632-709NS	A-42	2410-33	8053-029	C-4*	2620-23	1632-509TNS	A-42
187-05-19	1636-109NS	A-42	2410-35	8053-035	C-4*	2620-25	1628-509TNS	A-42
187-05-59	1636-509NS	A-42	2410-36	8053-037	C-4*	2620-27	1624-109TNS	A-42

* Download catalog section C to view product page at www.microaire.com

LINVATEC-STYLE DRILLS, PINS + WIRES

Linvatec	MicroAire	Page	Linvatec	MicroAire	Page	Linvatec	MicroAire	Page
262-02-79	1640-709TNS	A-42	47-186-76	1600-662	A-41	47-187-07-59	1648-509	A-42
2620-29	1624-509TNS	A-42	47-186-78	1600-962	A-41	47-187-07-69	1648-609	A-42
262-03-04	1636-609TNS	A-42	47-186-82	1600-9625	A-41	47-187-07-79	1648-709	A-42
2620-31	1620-109TNS	A-42	47-187-01-19	1620-109	A-42	47-2620-01	1636-109T	A-42
2620-33	1620-509TNS	A-42	47-187-01-59	1620-509	A-42	47-2620-03	1628-109T	A-42
2620-35	1600-962TNS	A-41	47-187-01-69	1620-609	A-42	47-262-01-04	1648-609T	A-42
2620-37	1600-945TNS	A-41	47-187-01-79	1620-709	A-42	47-2620-11	1648-109T	A-42
262-03-79	1636-709TNS	A-42	47-187-02-19	1624-109	A-42	47-2620-13	1648-509T	A-42
2620-39	1600-935TNS	A-41	47-187-02-59	1624-509	A-42	47-2620-15	1640-109T	A-42
262-05-04	1628-609TNS	A-42	47-187-02-69	1624-609	A-42	47-2620-17	1640-509T	A-42
262-05-79	1628-709TNS	A-42	47-187-02-79	1624-709	A-42	47-262-01-79	1648-709T	A-42
262-06-04	1624-609TNS	A-42	47-187-03-19	1628-109	A-42	47-2620-19	1636-509T	A-42
262-06-04	1632-609TNS	A-42	47-187-03-59	1628-509	A-42	47-262-02-04	1640-609T	A-42
262-06-79	1624-709TNS	A-42	47-187-03-69	1628-609	A-42	47-2620-21	1632-109T	A-42
262-06-79	1632-709TNS	A-42	47-187-03-79	1628-709	A-42	47-2620-23	1632-509T	A-42
262-07-04	1620-609TNS	A-42	47-187-04-19	1632-109	A-42	47-2620-25	1628-509T	A-42
262-07-79	1620-709TNS	A-42	47-187-04-59	1632-509	A-42	47-2620-27	1624-109T	A-42
286-50	1600-9355NS	A-41	47-187-04-69	1632-609	A-42	47-262-02-79	1640-709T	A-42
287-01-59	1620-509NS	A-42	47-187-04-79	1632-709	A-42	47-2620-29	1624-509T	A-42
47-186-04-14	1600-428	A-41	47-187-05-19	1636-109	A-42	47-262-03-04	1636-609T	A-42
47-186-04-16	1600-628	A-41	47-187-05-59	1636-509	A-42	47-2620-31	1620-109T	A-42
47-186-04-54	1604-128	A-41	47-187-05-69	1636-609	A-42	47-2620-33	1620-509T	A-42
47-186-44	1600-635	A-41	47-187-05-79	1636-709	A-42	47-2620-35	1600-962T	A-41
47-186-46	1600-935	A-41	47-187-06-19	1640-109	A-42	47-2620-37	1600-945T	A-41
47-186-50	1600-9355	A-41	47-187-06-59	1640-509	A-42	47-262-03-79	1636-709T	A-42
47-186-60	1600-645	A-41	47-187-06-69	1640-609	A-42	47-2620-39	1600-935T	A-41
47-186-62	1600-945	A-41	47-187-06-79	1640-709	A-42	47-262-05-04	1628-609T	A-42
47-186-66	1600-9455	A-41	47-187-07-19	1648-109	A-42	47-262-05-79	1628-709T	A-42

LINVATEC-STYLE DRILLS, PINS + WIRES

Linvatec	MicroAire	Page
47-262-06-04	1624-609T	A-42
47-262-06-04	1632-609T	A-42
47-262-06-79	1624-709T	A-42
47-262-06-79	1632-709T	A-42
47-262-07-04	1620-609T	A-42
47-262-07-79	1620-709T	A-42

All dimensions shown are nominal values subject to standard variances and tolerances.

MicroAire® is a registered trademark of MicroAire Surgical Instruments LLC.

The following companies are not affiliated with MicroAire Surgical Instruments LLC:

Conmed Corporation

Dyonics, Inc

Harris/Aesculap

Jacobs

Linvatec Corporation

Stryker

Synthes (USA)

Terumo

Zimmer, Inc

Dyonics® is a trademark of Smith&Nephew

Jacobs® is a registered trademark of Jacobs

Linvatec®, Hall®, Cebotome™, Osteon™, and Neurairtome™ Mini-Driver®, Maxi-Driver® and Maxion™ are trademarks of Linvatec® Corporation, a subsidiary of ConMed Corporation.

Stryker® is a registered trademark of Stryker Corporation

Synthes® is a registered trademark of DePuy Synthes

Terumo® is a registered trademark of Terumo Medical Corporation

Zimmer® is a registered trademark of Zimmer, Inc

MICROAIRE®
For Surgery. For Life.™

MicroAire Surgical Instruments

3590 Grand Forks Boulevard

Charlottesville, VA 22911 USA

800 722 0822 or +434 975 8000

www.microaire.com

© 2016 MicroAire Surgical Instruments, LLC
All rights reserved. LIT-DISPOSABLES-CAT REV A



A COLSON ASSOCIATE

B

Blades
for Large-Bone Power Systems

B-2

Blades
for Small-Bone Power Systems

B-23

Sternum Saw Blades

B-34

Burs

B-37

Rasps

B-41

STRYKER®

MICROAIRE®
For Surgery. For Life.™

Blades, Burs and Rasps

BLADES for Large-Bone Power Systems

Oscillating Saw Blades

Stryker®

Large-Power Saws

Models 277-30, 1320, 1420 and 1620

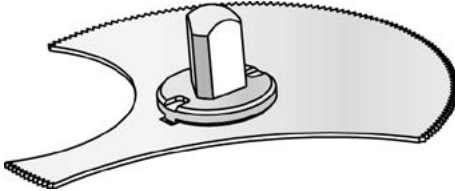
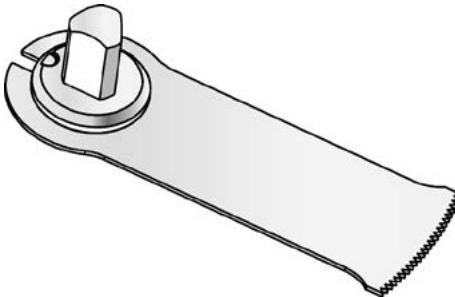
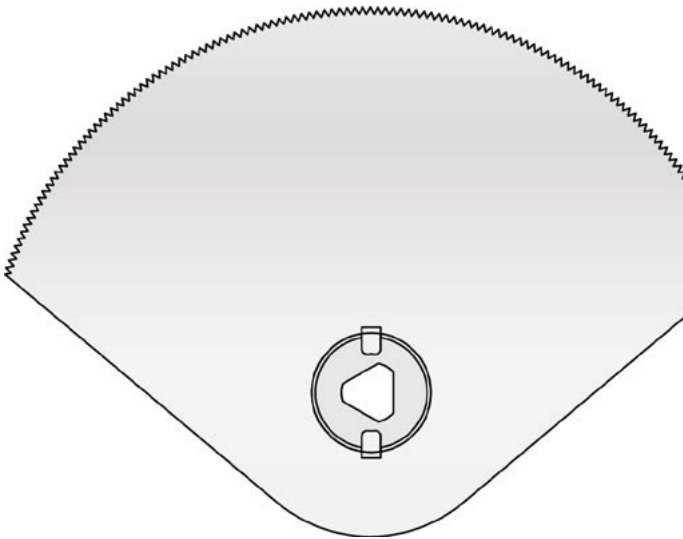
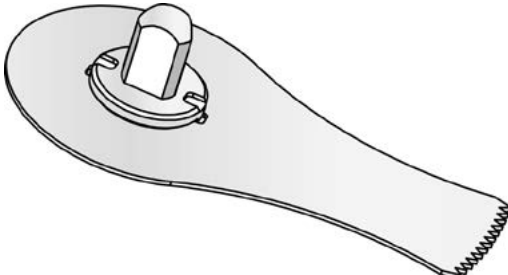
Part No.	Width (mm)	Usable Length (mm)	Cut Thickness (mm)	Material Thickness (mm)	TPI	
SO-010	61	20	0.90	0.60	21	
SO-016	21.8	43	1.0	0.60	20	
SO-020	96.5	41.3	1.0	0.60	16	
SO-116	20.6	31.2	1.0	0.60	16	

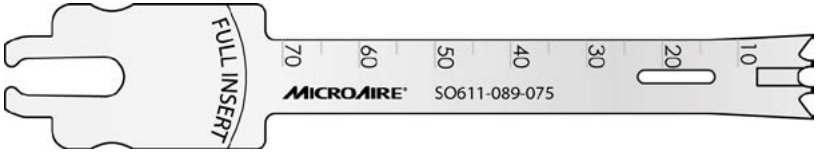
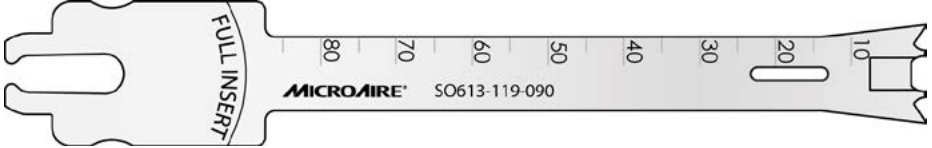
Part No.	Width (mm)	Usable Length (mm)	Cut Thickness (mm)	Material Thickness (mm)	TPI
SO611-089-075 Replaces 4111-089-075 D-Cut	11	75	0.89	0.89	16
SO611-089-090 Replaces 4111-089-090 D-Cut	11	90	0.89	0.89	16
SO611-107-090 Replaces 4111-107-075 D-Cut	11	90	1.07	1.07	16
SO611-119-090 Replaces 4111-119-090 D-Cut	11	90	1.19	1.19	16
SO611-127-090 Replaces 4111-127-090 D-Cut	11	90	1.27	1.27	16
SO611-135-090 Replaces 4118-135-090 D-Cut	11	90	1.35	1.35	16
SO611-147-075 Replaces 4111-147-075 D-Cut	11	75	1.47	1.47	16
					
SO613-119-090 Replaces 4113-119-090 D-Cut	13	90	1.19	1.19	16
					

Part No.	Width (mm)	Usable Length (mm)	Cut Thickness (mm)	Material Thickness (mm)	TPI
SO618-089-075 Replaces 4118-089-075 D-Cut	18	75	0.89	0.89	16
SO618-097-090 Replaces 4118-097-090 D-Cut	18	90	0.97	0.97	16
SO618-119-090 Replaces 4118-119-090 D-Cut	18	90	1.19	1.19	16
SO618-127-075 Replaces 4118-127-075 D-Cut	18	75	1.27	1.27	16
SO618-127-090 Replaces 4118-127-090 D-Cut	18	90	1.27	1.27	16
SO618-127-100 Replaces 4118-127-100 D-Cut	18	100	1.27	1.27	16
SO618-135-090 Replaces 4118-135-090 D-Cut	18	90	1.35	1.35	16
SO618-135-105 Replaces 4118-135-105 D-Cut	18	105	1.35	1.35	16
SO618-147-105 Replaces 4118-147-105 D-Cut	18	105	1.47	1.47	16



Part No.	Width (mm)	Usable Length (mm)	Cut Thickness (mm)	Material Thickness (mm)	TPI
SO625-064-075 Replaces 4125-064-075 D-Cut	25	75	0.64	0.64	16
SO625-089-075 Replaces 4125-089-075 D-Cut	25	75	0.89	0.89	16





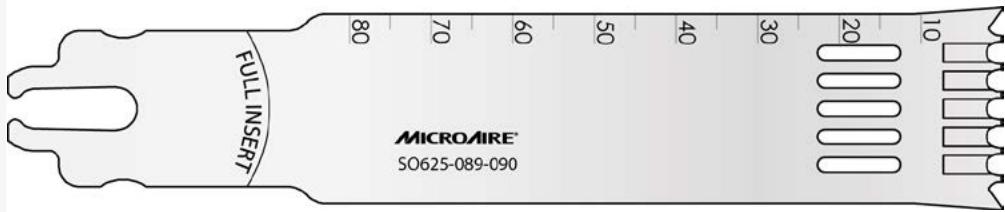



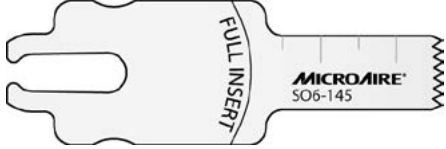

SO625-089-090 Replaces 4125-089-090 D-Cut	25	90	0.89	0.89	16
SO625-097-090 Replaces 4125-097-090 D-Cut	25	90	0.97	0.97	16
SO625-107-090 Replaces 4125-107-090 D-Cut	25	90	1.07	1.07	16
SO625-119-090 Replaces 4125-119-090 D-Cut	25	90	1.19	1.19	16
SO625-127-090 Replaces 4125-127-090 D-Cut	25	90	1.27	1.27	16
SO625-127-100 Replaces 4125-127-100 D-Cut	25	100	1.27	1.27	16
SO625-135-090 Replaces 4125-135-090 D-Cut	25	90	1.35	1.35	16
SO625-147-090 Replaces 4125-147-090 D-Cut	25	90	1.47	1.47	16

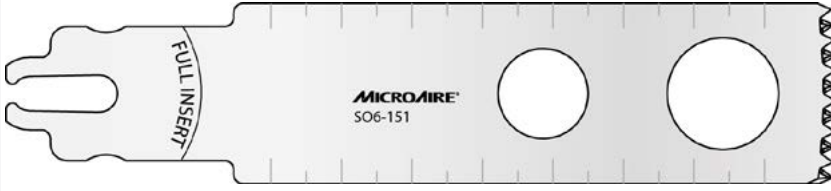
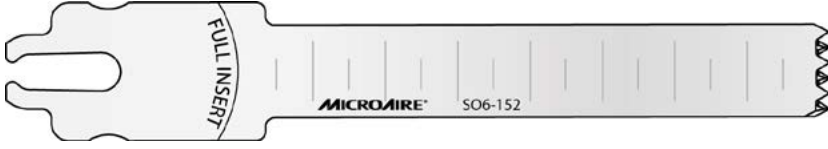



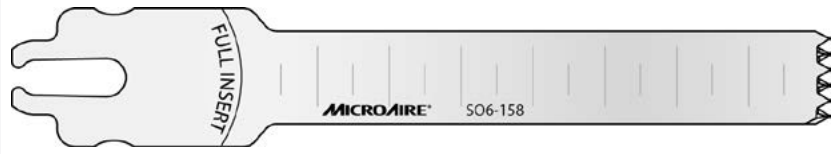

Part No.	Width (mm)	Usable Length (mm)	Cut Thickness (mm)	Material Thickness (mm)	TPI
SO6-100 Replaces 2108-100 Standard Offset	25	73	1.0	0.64	16
SO6-102 Replaces 2108-102 Standard Offset	25	89.5	1.0	0.89	12
SO6-103 Replaces 2108-103 Standard Offset	12.5	89.5	1.0	0.89	16
SO6-105 Replaces 2108-105 Standard Offset	25	73	1.0	0.89	12
SO6-109 Replaces 2108-109 Standard Offset	19	84.5	1.0	0.89	12

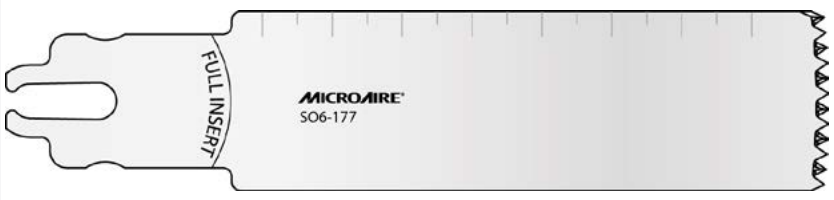
Part No.	Width (mm)	Usable Length (mm)	Cut Thickness (mm)	Material Thickness (mm)	TPI	
SO6-110 Replaces 2108-110 Standard Offset	25	73	1.47	1.27	12	
SO6-111 Replaces 2108-111 Standard Offset	25	79.5	1.47	1.27	12	
SO6-113 Replaces 2108-113 Standard Offset	16.5	34	1.73	1.27	12	
SO6-115 Replaces 2108-115 Standard Offset	18.5	73	0.89	0.81	12	
SO6-118 Replaces 2108-118 Diamond Ground	25	79.5	1.24	1.24	12	
SO6-120 Replaces 2108-120 Standard Offset	18.5	60.5	0.99	0.64	12	
SO6-131 Replaces 2108-131 Standard Offset	17.5	47.5	1.0	0.64	22	
SO6-140 Replaces 2108-140 Standard Offset	29	58	1.0	0.64	12	

Part No.	Width (mm)	Usable Length (mm)	Cut Thickness (mm)	Material Thickness (mm)	TPI	
SO6-144 Replaces 2108-144 Standard Offset	5.8	24	0.80	0.64	12	
SO6-145 Replaces 2108-145 Standard Offset	9	24	0.80	0.64	22	
SO6-148 Replaces 2108-148 Standard Offset	9	34.5	0.80	0.64	22	
SO6-150 Replaces 2108-150 Standard Offset	12.5	70	1.0	0.64	16	
SO6-151 Replaces 2108-151 Diamond Ground	25	85	1.19	1.19	12	
SO6-152 Replaces 2108-152 Diamond Ground	12.5	81.5	1.19	1.19	12	
SO6-155 Replaces 2108-140 Standard Offset	12.5	73	1.47	1.27	12	

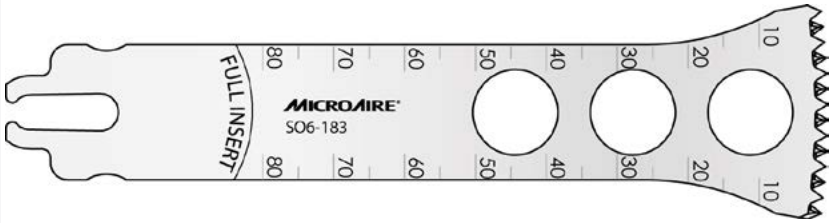
Part No.	Width (mm)	Usable Length (mm)	Cut Thickness (mm)	Material Thickness (mm)	TPI	
SO6-156 Replaces 2108-156 Standard Offset	12.5	79.5	1.47	1.27	12	
SO6-158 Replaces 2108-158 Diamond Ground	12.5	81.5	1.27	1.27	12	
SO6-160 Replaces 2108-160 Standard Offset	25	73	1.3	0.89	12	
SO6-175 Replaces 2108-175 Standard Offset	9.5	60.5	1.0	0.64	12	
SO6-176 Replaces 2108-176 Diamond Ground	25	79.5	1.5	1.5	12	
SO6-177 Replaces 2108-177 Diamond Ground	25	86.5	1.32	1.32	12	

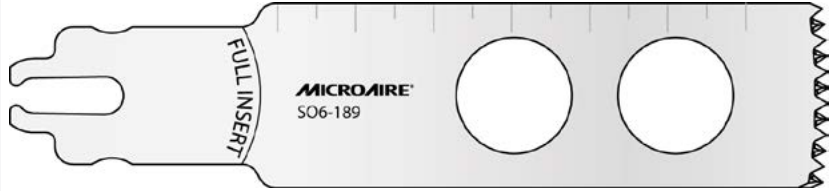
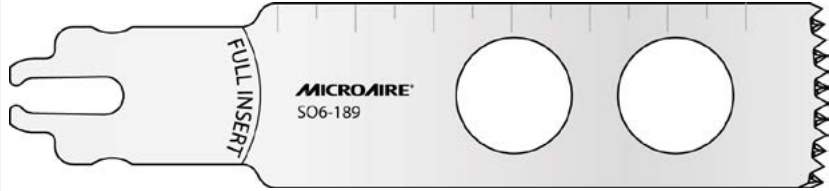



Part No.	Width (mm)	Usable Length (mm)	Cut Thickness (mm)	Material Thickness (mm)	TPI
SO6-182 Replaces 2108-182 Diamond Ground	18.5	83.5	1.24	1.24	12
					
SO6-182-10 Replaces 2108-182-010 Diamond Ground	18.5	100	1.24	1.24	12
					
SO6-183 Replaces 2108-183 Diamond Ground	29	83.5	1.24	1.24	12
					
SO6-185 Replaces 2108-185 Diamond Ground	18.5	104	1.24	1.24	12
					
SO6-189 Replaces 2108-189 Diamond Ground	25	81.5	1.27	1.27	12
					
SO6-193 Replaces 2108-193 Diamond Ground	25	81.5	1.04	1.04	12
					

Part No.	Width (mm)	Usable Length (mm)	Cut Thickness (mm)	Material Thickness (mm)	TPI
SO6-195 Replaces 2108-195 Diamond Ground	48.5	90	0.96	0.96	18
SO6-197 Replaces 2108-197 Standard Offset	48.5	61	1.08	0.64	18
SO6-218 Replaces 2108-218 Diamond Ground	25	98.5	1.24	1.24	12
SO6-302 Replaces 2108-302 Diamond Ground	25	89.5	0.89	0.89	12





Part No.	Width (mm)	Usable Length (mm)	Cut Thickness (mm)	Material Thickness (mm)	TPI
SO6-305 Replaces 2108-305 Diamond Ground	25	73	0.89	0.89	12
SO6-309 Replaces 2108-309 Diamond Ground	19	84.5	0.89	0.89	12
SO6-310 Replaces 2108-310 Diamond Ground	25	73	1.24	1.24	12
SO6-356 Replaces 2108-356 Diamond Ground	12.5	79	1.24	1.24	12
SO6-390 Diamond Ground	19	90	1.37	1.37	12





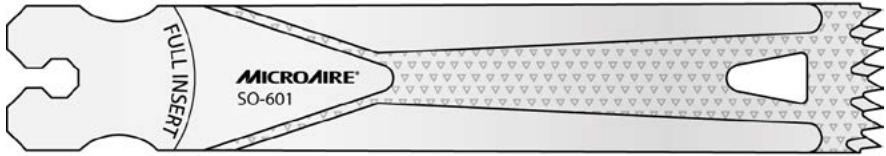

Sagittal Saw Blades





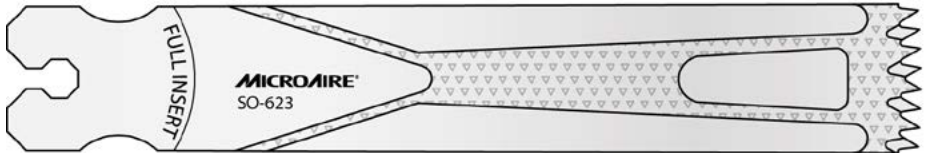

Stryker® Large-Power Saws, System 2000, 4 and 5







Part No.	Width (mm)	Usable Length (mm)	Cut Thickness (mm)	Material Thickness (mm)	TPI
SO11-089-075 D-Cut	11	75	0.89	0.89	16
SO11-089-090 D-Cut	11	90	0.89	0.89	16
SO11-107-090 D-Cut	11	90	1.07	1.07	16
SO11-119-090 D-Cut	11	90	1.19	1.19	16
SO11-127-090 D-Cut	11	90	1.27	1.27	16
SO11-135-090 D-Cut	11	90	1.35	1.35	16
SO11-147-075 D-Cut	11	75	1.47	1.47	16
					
SO13-119-090 D-Cut	13	90	1.19	1.19	16
					
SO18-089-075 D-Cut	18	75	0.89	0.89	16
SO18-089-090 D-Cut	18	90	0.89	0.89	16
SO18-097-090 D-Cut	18	90	0.97	0.97	16
SO18-119-090 D-Cut	18	90	1.19	1.19	16
SO18-127-075 D-Cut	18	75	1.27	1.27	16
					
SO18-127-090 D-Cut	18	90	1.27	1.27	16
SO18-127-100 D-Cut	18	100	1.27	1.27	16
SO18-135-090 D-Cut	18	90	1.35	1.35	16
					





Part No.	Width (mm)	Usable Length (mm)	Cut Thickness (mm)	Material Thickness (mm)	TPI
SO18-135-105 D-Cut	18	105	1.35	1.35	16
SO18-147-105 D-Cut	18	105	1.47	1.47	16
SO25-064-075 D-Cut	25	75	0.64	0.64	16
SO25-089-075 D-Cut	25	75	0.89	0.89	16
SO25-089-090 D-Cut	25	90	0.89	0.89	16
SO25-097-090 D-Cut	25	90	0.97	0.97	16
SO25-107-090 D-Cut	25	90	1.07	1.07	16
SO25-119-090 D-Cut	25	90	1.19	1.19	16
SO25-127-090 D-Cut	25	90	1.27	1.27	16
SO25-127-100 D-Cut	25	100	1.27	1.27	16
SO25-135-090 D-Cut	25	90	1.35	1.35	16
SO25-147-090 D-Cut	25	90	1.47	1.47	16

Part No.	Width (mm)	Usable Length (mm)	Cut Thickness (mm)	Material Thickness (mm)	TPI	
SO-600 Standard Offset	25.4	70	1.0	0.60	16	
SO-601 Photo-Etch Aggressive	19.5	90	1.27	1.27	10	
SO-602 Standard Offset	25.4	90	1.0	0.90	12	
SO-605 Standard Offset	25.4	70	1.0	0.90	12	
SO-609 Standard Offset	19.1	85	1.0	0.90	12	
SO-610 Standard Offset	25.4	70	1.40	1.27	12	
SO-611 Standard Offset	25.4	85	1.47	1.27	12	

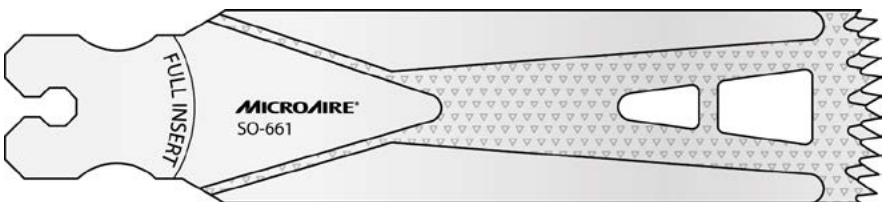

Part No.	Width (mm)	Usable Length (mm)	Cut Thickness (mm)	Material Thickness (mm)	TPI	
SO-615 Standard Offset	19.1	70	0.90	0.80	12	
SO-618 Diamond Ground	25.4	85	1.27	1.27	12	
SO-620 Standard Offset	19.1	58	0.90	0.60	12	
SO-623 Photo-Etch Aggressive	19.5	95	1.27	1.27	10	
SO-6302 Diamond Ground	25.4	90	0.89	0.89	12	
SO-6305 Diamond Ground	25.4	75	0.89	0.89	12	
SO-6309 Diamond Ground	19.1	90	0.89	0.89	12	

Part No.	Width (mm)	Usable Length (mm)	Cut Thickness (mm)	Material Thickness (mm)	TPI	
SO-6318 Diamond Ground	25.4	80	1.24	1.24	12	
SO-6352 Diamond Ground	12.7	85	1.19	1.19	12	
SO-6356 Diamond Ground	12.7	80	1.24	1.24	12	
SO-6380 Diamond Ground	19	70	1.37	1.37	12	
SO-6390 Diamond Ground	19	90	1.35	1.35	12	
SO-640 Standard Offset	30.5	60	1.0	0.64	12	
SO-645 Standard Offset	9.7	25	0.80	0.64	18	

Part No.	Width (mm)	Usable Length (mm)	Cut Thickness (mm)	Material Thickness (mm)	TPI	
SO-648 Standard Offset	9	34	0.80	0.64	22	
SO-650 Standard Offset	12.7	70	1.0	0.64	16	
SO-651 Diamond Ground	25.4	85	1.19	1.19	12	
SO-651L Diamond Ground	25.4	95	1.19	1.19	12	
SO-655 Standard Offset	12.7	70	1.47	1.20	12	
SO-656 Standard Offset	12.7	80	1.47	1.20	12	
SO-658 Standard Offset	12.7	94	1.35	1.20	12	
SO-6580 Diamond Ground	12.7	90	1.37	1.37	12	



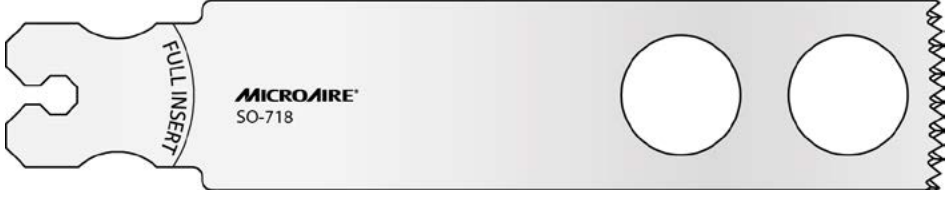



Part No.	Width (mm)	Usable Length (mm)	Cut Thickness (mm)	Material Thickness (mm)	TPI	
SO-660 Standard Offset	25.4	73	1.30	0.89	12	
SO-661 Photo-Etch Aggressive	25.4	90	1.27	1.27	10	
SO-663 Photo-Etch Aggressive	25.4	90	1.37	1.37	10	
SO-675 Standard Offset	9.5	60.5	1.0	0.64	18	
SO-676 Standard Offset	25.4	79	1.63	1.50	12	
SO-677 Diamond Ground	25.4	85	1.32	1.32	12	
SO-682 Diamond Ground	19.1	85	1.24	1.24	12	

Part No.	Width (mm)	Usable Length (mm)	Cut Thickness (mm)	Material Thickness (mm)	TPI
SO-683 Diamond Ground	30.5	85	1.24	1.24	12
SO-685 Diamond Ground	19	105	1.24	1.24	12
SO-689 Standard Offset	25.4	85	1.37	1.27	12
SO-696 Photo-Etch Aggressive	25.4	90	0.90	0.90	10
SO-699 Diamond Ground	25.4	85	1.19	1.19	12

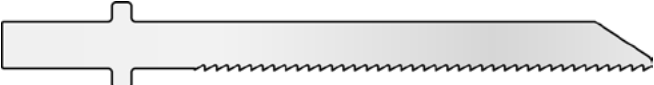
Part No.	Width (mm)	Usable Length (mm)	Cut Thickness (mm)	Material Thickness (mm)	TPI
SO-718 Diamond Ground	25	98	1.24	1.24	12
					
SO-750 Standard Offset	12.7	85	1.0	0.89	16
					

Reciprocating Saw Blades

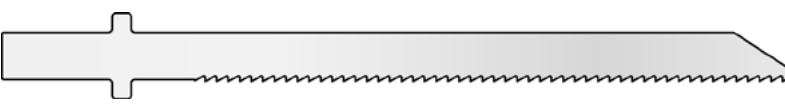
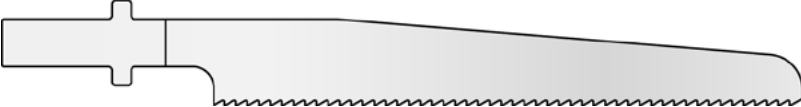

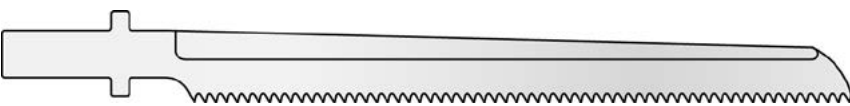







Stryker® Large-Power Saws

Part No.	Width (mm)	Usable Length (mm)	Cut Thickness (mm)	Material Thickness (mm)	TPI	
SR-250	6.2	60.2	1.0	0.64	16	
SR-251	6.4	47.5	1.0	0.80	16	
SR-275	12.7	78.7	1.0	0.80	20	
SR-277	12.7	68	1.15	1.0	20	
SR-281	12.7	68	1.37	1.25	20	
SR-300	6.4	78.7	1.0	0.64	16	
SR-325	11.2	77.7	1.0	0.80	16	
SR-326	11	77.7	1.6	1.20	16	
SR-350	9.4	87.8	1.0	0.94	18	

BLADES for Small-Bone Power Systems

Oscillating Saw Blades

Stryker® Micro-Oscillating Saw Models 296-31, 277-31



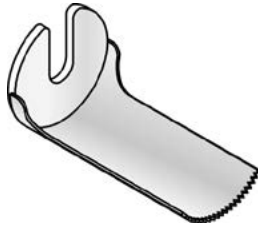
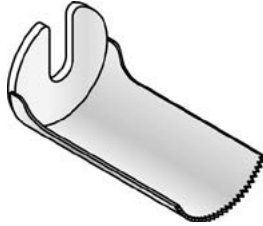
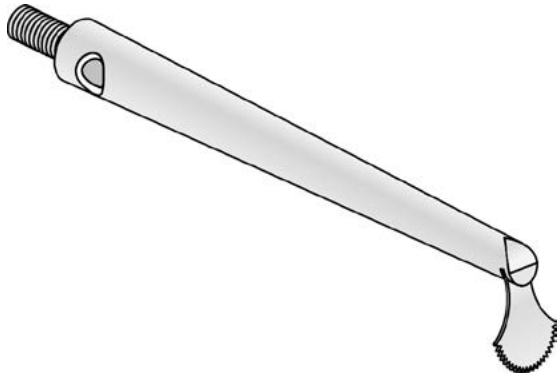



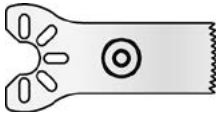

Part No.	Width (mm)	Usable Length (mm)	Cut Thickness (mm)	Material Thickness (mm)	TPI	
SO-103	9.7	25.4	0.7	0.4	22	
SO-410	5.5	12	0.7	0.4	32	
SO-411	9.7	12	0.7	0.4	32	
SO-412	5.5	20	0.7	0.4	32	
SO-413	9.6	20	0.7	0.4	32	
SO-414	5.5	25	0.7	0.4	32	
SO-510	5.5	12	0.6	0.4	32	
SO-512	5.5	18	0.6	0.4	32	
SO-513	9.5	20	0.6	0.4	32	
SO-515	9.5	31.2	0.6	0.4	32	

Type	Part No.	Width (mm)	Usable Length (mm)	Cut Thickness (mm)	Material Thickness (mm)	TPI	
Crescentic Saw Blades	SO-415	9.1	16.5	0.6	0.4	32	
	SO-416	16.5	24.1	0.6	0.4	32	
	SO-417	20.3	24.1	0.6	0.4	32	
Mandibular Saw Blade	SO-434	11.2	12	0.8	0.5	22	

Oscillating + Sagittal Saw Blades







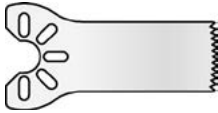

Stryker® Power Instruments

6400-34-000, 6400-031-000, 5400-031-000,
5400-034-000, 5100-034-000, 4100-400-000,
2296-080-134, 2296-031-000, 2296-032-000,
2296-231-000, 2296-234-000

Part No.	Width (mm)	Usable Length (mm)	Cut Thickness (mm)	Material Thickness (mm)	TPI	
SP-051	6.6	18.5	0.38	0.38	32	
SP-101	9	10	0.38	0.38	32	
SP-101A	9	10	0.51	0.51	32	
SP-102	16.8	18.5	0.38	0.38	32	
SP-102A	16.8	18.5	0.51	0.51	32	
SP-103	7	15	0.38	0.38	32	
SP-103A	7	15	0.51	0.51	32	
SP-104	16.5	34.5	0.38	0.38	32	
SP-104A	16.5	34.5	0.51	0.51	32	
SP-105	9	18.5	0.38	0.38	32	



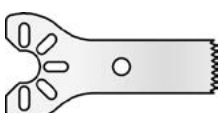
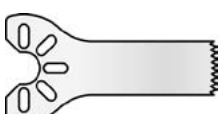





6400-34-000, 6400-031-000, 5400-031-000,
5400-034-000, 5100-034-000, 4100-400-000,
2296-080-134, 2296-031-000, 2296-032-000,
2296-231-000, 2296-234-000

Stryker® Power Instruments

Part No.	Width (mm)	Usable Length (mm)	Cut Thickness (mm)	Material Thickness (mm)	TPI	
SP-105A	9	18.5	0.51	0.51	32	
SP-106	13	34.5	0.38	0.38	32	
SP-106A	13	34.5	0.51	0.51	32	
SP-108	13	39	0.38	0.38	32	
SP-108A	13	39	0.51	0.51	32	
SP-111	9	24.6	0.38	0.38	32	
SP-111A	9	24.6	0.51	0.51	18	
SP-114	7	18.5	0.38	0.38	32	
SP-114A	7	18.5	0.51	0.51	32	
SP-115	7	29.5	0.38	0.38	32	



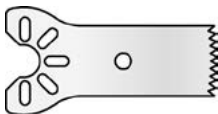
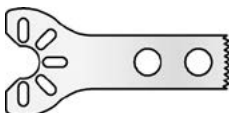







6400-34-000, 6400-031-000, 5400-031-000,
 5400-034-000, 5100-034-000, 4100-400-000,
 2296-080-134, 2296-031-000, 2296-032-000,
 2296-231-000, 2296-234-000

Stryker® Power Instruments

Part No.	Width (mm)	Usable Length (mm)	Cut Thickness (mm)	Material Thickness (mm)	TPI	
SP-115A	7	29.5	0.51	0.51	32	
SP-121	9	12	0.38	0.38	32	
SP-125	9	31	0.38	0.38	32	
SP-125A	9	31	0.51	0.51	32	
SP-150	9	20	0.64	0.64	32	
SP-151	9.5	11	0.64	0.64	32	
SP-152	9	16	0.64	0.64	32	
SP-155	9	18.5	0.38	0.38	32	
SP-194	7	20	0.38	0.38	32	
SP-206	12	34.5	0.38	0.38	22	







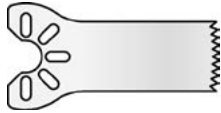

6400-34-000, 6400-031-000, 5400-031-000,
 5400-034-000, 5100-034-000, 4100-400-000,
 2296-080-134, 2296-031-000, 2296-032-000,
 2296-231-000, 2296-234-000

Stryker® Power Instruments

Part No.	Width (mm)	Usable Length (mm)	Cut Thickness (mm)	Material Thickness (mm)	TPI	
SP-206A	12	34.5	0.51	0.51	22	
SP-212	5.5	18.5	0.38	0.38	22	
SP-212A	5.5	18.5	0.5	0.5	22	
SP-214	19	41	0.38	0.38	32	
SP-220A	9	10	0.51	0.51	22	
SP-221	9	12	0.38	0.38	22	
SP-221A	9	12	0.51	0.51	22	
SP-224A	17	34.5	0.51	0.51	22	
SP-225	9	31	0.38	0.38	22	
SP-225A	9	31	0.51	0.51	22	

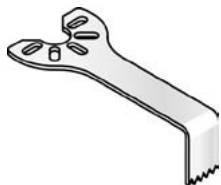
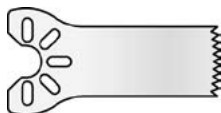





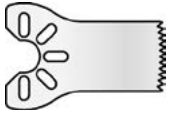
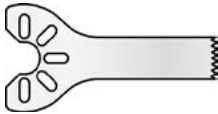

6400-34-000, 6400-031-000, 5400-031-000,
5400-034-000, 5100-034-000, 4100-400-000,
2296-080-134, 2296-031-000, 2296-032-000,
2296-231-000, 2296-234-000

Stryker® Power Instruments

Part No.	Width (mm)	Usable Length (mm)	Cut Thickness (mm)	Material Thickness (mm)	TPI	
SP-23-105	9	18.5	0.25	0.25	22	
SP-23-111	9	25	0.25	0.25	22	
SP-23-412	5.5	18.5	0.25	0.25	22	
SP-23-414	5.5	25	0.25	0.25	22	
SP-234A	5.5	9	0.90	0.62	22	
SP-255	9	18.5	0.38	0.38	22	
SP-410	5.5	11.5	0.38	0.38	32	
SP-410A	5.5	11.5	0.51	0.51	32	
SP-410R	19	41.6	0.64	0.51	22	
SP-411	9	11.5	0.38	0.38	32	



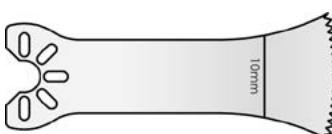







6400-34-000, 6400-031-000, 5400-031-000,
5400-034-000, 5100-034-000, 4100-400-000,
2296-080-134, 2296-031-000, 2296-032-000,
2296-231-000, 2296-234-000

Stryker® Power Instruments

Part No.	Width (mm)	Usable Length (mm)	Cut Thickness (mm)	Material Thickness (mm)	TPI	
SP-411A	9	11.5	0.51	0.51	32	
SP-412	5.5	18.5	0.38	0.38	32	
SP-412A	5.5	18.5	0.51	0.51	32	
SP-413	2.5	18.5	0.38	0.38	32	
SP-413A	2.5	18.5	0.51	0.51	32	
SP-414	5.5	25	0.38	0.38	32	
SP-414A	5.5	25	0.51	0.51	32	
SP-504	16.5	34.5	0.64	0.38	22	
SP-506	13	34.5	0.64	0.38	22	
SP-508	13	39	0.64	0.38	22	



6400-34-000, 6400-031-000, 5400-031-000,
 5400-034-000, 5100-034-000, 4100-400-000,
 2296-080-134, 2296-031-000, 2296-032-000,
 2296-231-000, 2296-234-000

Stryker® Power Instruments

Part No.	Width (mm)	Usable Length (mm)	Cut Thickness (mm)	Material Thickness (mm)	TPI	
SP-511	9	24.6	0.64	0.38	22	
SP-515	13.4	39	0.64	0.38	22	
SP-519A	9	31	0.51	0.51	22	
SP-520A	9	35	0.64	0.64	22	
SP-521	9	12	0.64	0.38	22	
SP-521A	9	25	0.51	0.51	22	
SP-522A	9	25	0.64	0.64	22	
SP-524	5.5	25	0.64	0.38	22	
SP-525	9	31	0.64	0.38	22	
SP-526A	13	39	0.51	0.51	22	

6400-34-000, 6400-031-000, 5400-031-000,
5400-034-000, 5100-034-000, 4100-400-000,
2296-080-134, 2296-031-000, 2296-032-000,
2296-231-000, 2296-234-000









Stryker® Power Instruments



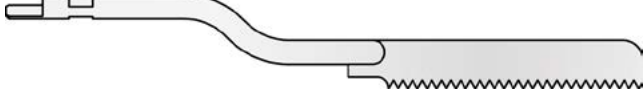







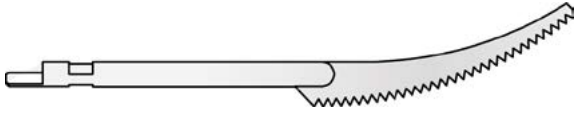

Part No.	Width (mm)	Usable Length (mm)	Cut Thickness (mm)	Material Thickness (mm)	TPI	
SP-528	9	8	0.64	0.38	22	
SP-529	9	10	0.64	0.38	22	
SP-530	9	18	0.64	0.38	22	

Reciprocating Saw Blades

Stryker® Reciprocating Saws

Models 5400-037-000, 5100-037-000 and 2296-037-000

Part No.	Width (mm)	Usable Length (mm)	Cut Thickness (mm)	Material Thickness (mm)	TPI	
SR-51-007	6.3	27	0.5	0.38	20	
SR-51-007L	6.3	27	0.5	0.38	20	
SR-51-007T	6.3	27	1.0	0.64	20	
SR-51-137-103	6.3	33.5	0.5	0.38	20	
SR-51-137-106	6.3	25	0.5	0.38	22	
SR-51-137-11	6.3	14.5	0.5	0.38	20	
SR-51-137-12	6.3	33.5	0.5	0.38	20	
SR-51-137-120	6.3	7	0.5	0.38	22	
SR-51-137-121	6.3	14.5	0.5	0.38	20	

Part No.	Width (mm)	Usable Length (mm)	Cut Thickness (mm)	Material Thickness (mm)	TPI	
SR-51-137-20	6.3	34	0.5	0.38	20	
SR-51-137-44	6.3	16	0.5	0.38	22	
SR-51-337-107	6.3	23	0.5	0.38	22	
SR-51-337-111	6.3	16	0.5	0.38	22	
SR-51-337-12	6.3	33.5	0.5	0.38	20	
SR-51-337-121	6.3	14.5	0.5	0.38	20	
SR-51-337-123	6.3	26	0.5	0.38	20	
SR-51-337-20	6.3	34	0.5	0.38	20	
SR-51-707	6	23	0.5	0.38	20	
SR-51-723	6.3	26	0.5	0.38	20	
SR-51-733	6.3	22.5	0.5	0.38	20	
SR-51-733L	6.3	22.5	0.5	0.38	20	

STERNUM SAW BLADES

Sternum Saw Blades

Stryker® Ortho Power OP 90

Part No.	Width (mm)	Usable Length (mm)	Cut Thickness (mm)	Material Thickness (mm)	TPI
SO-125	42	45	1.1	0.6	22

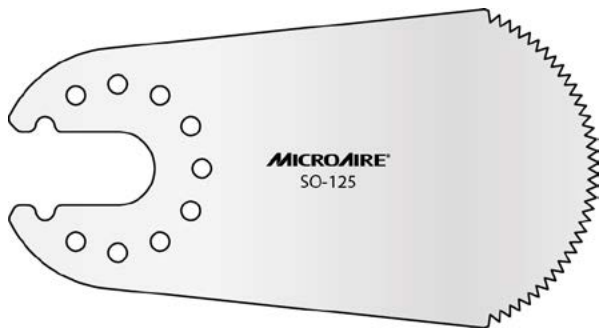

The diagram shows a curved saw blade with a serrated edge. It features a central notch and two side notches. The text 'MICROAIRE SO-125' is printed on the blade.

Stryker® System 6

Part No.	Width (mm)	Usable Length (mm)	Cut Thickness (mm)	Material Thickness (mm)	TPI
SO6-125 Replaces 2108-125 Standard Offset	40.5	47.5	1.1	0.64	22

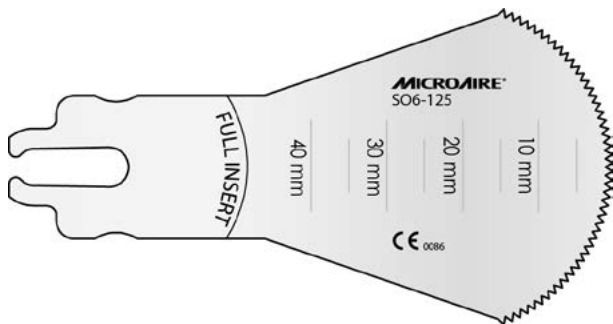

The diagram shows a curved saw blade with a serrated edge. It features a central notch and two side notches. The text 'MICROAIRE SO6-125' and 'FULL INSERT' are printed on the blade. Dimensions are indicated: 40 mm, 30 mm, 20 mm, and 10 mm. A CE mark is also present.

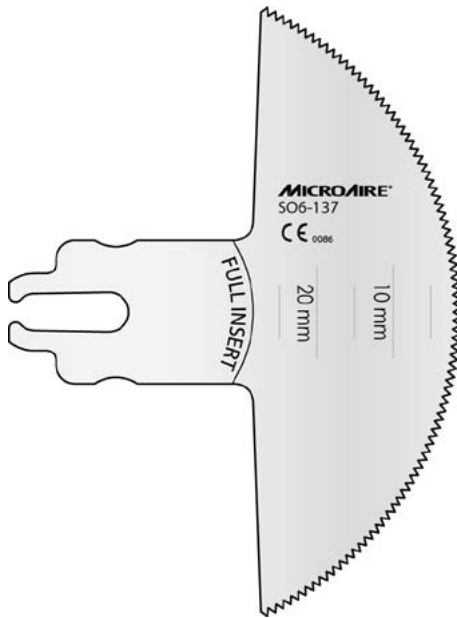

SO6-137 Replaces 2108-137 Standard Offset	80	28	1.0	0.64	21
--	----	----	-----	------	----



The diagram shows a curved saw blade with a serrated edge. It features a central notch and two side notches. The text 'MICROAIRE SO6-137' and 'FULL INSERT' are printed on the blade. Dimensions are indicated: 20 mm and 10 mm. A CE mark is also present.

Part No.	Width (mm)	Usable Length (mm)	Cut Thickness (mm)	Material Thickness (mm)	TPI	
SO-625	41.9	45	1.1	0.6	22	
SO-637	80	28	1.0	0.64	21	

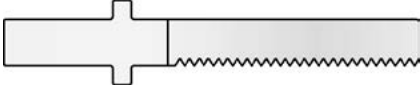
Stryker® Sternum Saw Models 4107, 298-97, 297-87, 296-87, 296-97, 2107

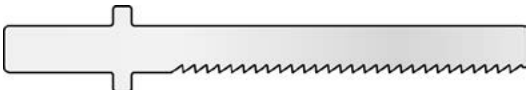
Part No.	Width (mm)	Usable Length (mm)	Cut Thickness (mm)	Material Thickness (mm)	TPI	
SR-027	6.4	32.4	1.0	0.8	20	
SR-100	6.1	32.3	1.0	0.8	20	
SR-101	6.1	32	1.0	0.64	16	
SR-101L	6.1	46.7	1.0	0.64	16	

Terumo® Sarns II™ Sternum Saw 5590

Part No.	Width (mm)	Usable Length (mm)	Cut Thickness (mm)	Material Thickness (mm)	TPI	
TR-032	6	31.5	1.1	0.79	18	

Cast Cutter Saw Blade



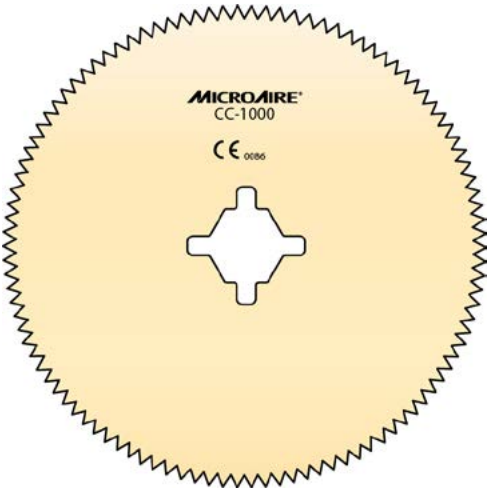









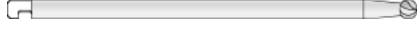
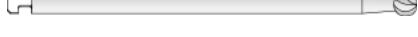

Stryker® 840-40-350

Part No.	Width (mm)	Usable Length (mm)	Cut Thickness (mm)	Material Thickness (mm)	TPI	
CC-1000NS	19	63.5	1.0	0.6	16	















BURS

Osteotomy Drill Burs

Stryker® RotoOsteotome® and Micro Drills Stainless Steel









Type	Part No.	Head Size Diameter (mm)	Head Length (mm)	# of Flutes	Overall Length (mm)	
Barrel	K-01	6	11.2	14	44.5	
Egg	K-02	4	9.7	10	44.5	
	K-03	6	9.7	14	44.5	
Pear	K-04	6	10.4	14	44.5	
Round	K-05	8	8	16	44.5	
Flame	K-08	6	12.7	14	47.5	
Round	K-09	1.6	1.6	6	54.1	
	K-10	2.3	2.3	8	54.1	
	K-11	3.1	3.1	10	54.1	
	K-12	4	4	12	54.1	
	K-13	4.7	4.7	12	54.1	
	K-14	6	6	16	44.5	
	K-15	7	7	14	44.5	
Wire Pass Drill	K-16	1.1	12.7	2	63.2	
	K-17	1.3	19.1	2	53.8	
	K-18	1.6	19.1	2	66.5	
	K-19	2	28.4	2	66.5	

Stryker® RotoOsteotome® and Micro Drills Stainless Steel

Type	Part No.	Head Size Diameter (mm)	Head Length (mm)	# of Flutes	Overall Length (mm)	
Fissure	K-20	3.2	11.2	8	54.1	
Serrated Bone Drill	K-21	2.3	9.5	4	54.1	
Lindemann Drill	K-22	2.2	23.9	4	65.0	
Drill	K-23	1.5	1.8	2	66.8	
Tapered Side Cutting	K-25	2.1	22.9	3	66.8	
Swanson Pilot Point	K-26	2	11	4	55.6	
	K-27	3	13.6	5	62	
	K-28	4	13.6	6	62	
Side Cutting	K-32	2.1	9.7	3	53.8	
Barrel	K-33	6	11.2	14	54.1	
Egg	K-34	6	9.7	14	54.1	
Pear	K-35	6	10.4	14	54.1	
Round	K-36	6	6	15	54.1	
Egg	K-38	4	9.7	10	54.1	









Otology Drill Burs

Stryker® RotoOsteotome® and Micro Drills Stainless Steel

Type	Part No.	Head Size Diameter (mm)	Head Length (mm)	# of Flutes	Overall Length (mm)	
Round Diamond	K-40	1	1	0	54.1	
	K-41	1.5	1.5	0	54.1	
	K-42	2	2	0	54.1	
	K-43	2.5	2.5	0	54.1	
	K-44	3	3	0	54.1	
	K-45	3.5	3.5	0	54.1	
	K-46	4	4	0	54.1	
	K-47	4.5	4.5	0	54.1	
	K-48	5	5	0	54.1	





Fast-Cutting Otology Burs

Stryker® RotoOsteotome® and Micro Drills Stainless Steel

Type	Part No.	Head Size Diameter (mm)	Head Length (mm)	# of Flutes	Overall Length (mm)	
Round	K-50	2.4	2.4	6	54.1	
	K-51	3.2	3.2	6	54.1	
	K-52	4	4	6	54.1	
	K-53	4	4	8	54.1	
	K-54	4.8	4.8	6	52.3	
	K-55	4.8	4.8	8	52.3	
	K-56	5.5	5.5	8	52.3	
	K-57	6.3	6.3	8	52.3	
	K-58	7.1	7.1	8	52.3	









Polishing Otology Burs

Stryker® RotoOsteotome® and Micro Drills Stainless Steel

Type	Part No.	Head Size Diameter (mm)	Head Length (mm)	# of Flutes	Overall Length (mm)	
Round	K-60	1	1	12	54.1	
	K-62	2	2	18	54.1	
	K-64	3	3	20	54.1	
	K-65	4	4	25	54.1	



Oral Surgery Burs

Stryker® RotoOsteotome® and Micro Drills Carbide

Type	Part No.	Head Size Diameter (mm)	Head Length (mm)	# of Flutes	Overall Length (mm)	
Round	K-70	2.3	2.3	6	44.5	
Side-Cutting	K-71	1.6	4.6	6	44.5	
	K-72	1.2	4.2	6	44.5	
	K-73	1.6	4.6	6	44.5	
	K-74	2.1	4.6	6	44.5	
Round	K-75	1.8	1.8	6	44.5	
Side-Cutting	K-76	1.2	4.1	6	44.5	
	K-77	1.8	5.8	6	44.5	
Cross-Cut Fissure	K-78	2.1	4.6	8	44.5	

Extra-Long Burs



Stryker® Neuro® Drills Stainless Steel







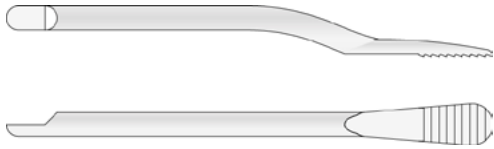
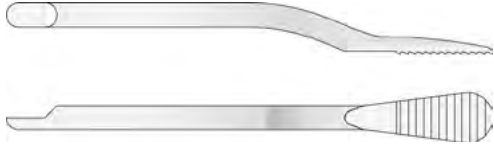

Type	Part No.	Head Size Diameter (mm)	Head Length (mm)	# of Flutes	Overall Length (mm)	
Round	K-137	4	4	8	114.3	
	K-147	2.4	2.4	6	114.3	

RASPS

Rasps

Stryker® Reciprocating Saw

Type	Part No.	Width (mm)	Usable Length (mm)	
Small Straight-Cut	SR-080	5.5	9.5	
Large Straight-Cut	SR-081	6.5	12.5	
Small Cross-Cut	SR-082	5.5	9.5	
Large Cross-Cut	SR-083	6.5	12.5	

Type	Part No.	Width (mm)	Usable Length (mm)	
Small Tear	SR-51-080	5	10.7	
				
Large Tear	SR-51-081	7	12.7	
				
Small Tear Cross-Cut	SR-51-082	5	11	
				
Large Tear Cross-Cut	SR-51-083	7	14	
				

STRYKER-STYLE BLADES, BURS + RASPS

Stryker	MicroAire	Page	Stryker	MicroAire	Page	Stryker	MicroAire	Page
1100	SO-010	B-2	1608-2-013	K-13	B-37	1608-6-141	K-56	B-39
1105	SO-020	B-2	1608-2-015	K-36	B-38	1608-6-143	K-57	B-39
1106	SO-016	B-2	1608-2-021	K-21	B-38	1608-6-145	K-58	B-39
1608-2-063	K-16	B-37	1608-2-035	K-38	B-38	1608-6-147	K-50	B-39
1607-2-001	K-01	B-37	1608-2-043	K-22	B-38	1608-6-149	K-51	B-39
1607-2-003	K-03	B-37	1608-2-045	K-23	B-38	1608-6-151	K-52	B-39
1607-2-005	K-04	B-37	1608-2-049	K-25	B-38	1608-6-153	K-54	B-39
1607-2-015	K-14	B-37	1608-2-055	K-12	B-37	1608-6-155	K-60	B-40
1607-2-017	K-15	B-37	1608-2-059	K-18	B-37	1608-6-159	K-62	B-40
1607-2-035	K-02	B-37	1608-2-061	K-19	B-37	1608-6-163	K-64	B-40
1607-2-041	K-05	B-37	1608-2-071	K-17	B-37	1608-6-165	K-65	B-40
1607-2-047	K-08	B-37	1608-2-101	K-32	B-38	1608-6-167	K-20	B-38
1607-2-101	K-70	B-40	1608-2-131	K-26	B-38	1608-9-137	K-137	B-40
1607-2-103	K-71	B-40	1608-2-133	K-27	B-38	1608-9-147	K-147	B-40
1607-2-105	K-72	B-40	1608-2-135	K-28	B-38	1675-113	SR-082	B-41
1607-2-107	K-73	B-40	1608-6-083	K-40	B-39	1675-114	SR-083	B-41
1607-2-109	K-74	B-40	1608-6-085	K-41	B-39	1675-115	SR-080	B-41
1607-2-111	K-75	B-40	1608-6-087	K-42	B-39	1675-116	SR-081	B-41
1607-2-113	K-76	B-40	1608-6-089	K-43	B-39	2107-175	SO-675	B-19
1607-2-116	K-77	B-40	1608-6-091	K-44	B-39	2108-100	SO6-100	B-6
1608-2-001	K-33	B-38	1608-6-093	K-45	B-39	2108-100	SO-600	B-15
1608-2-003	K-34	B-38	1608-6-095	K-46	B-39	2108-102	SO6-102	B-6
1608-2-005	K-35	B-38	1608-6-097	K-47	B-39	2108-102	SO-602	B-15
1608-2-007	K-09	B-37	1608-6-099	K-48	B-39	2108-103	SO6-103	B-6
1608-2-009	K-10	B-37	1608-6-137	K-53	B-39	2108-103	SO-750	B-21
1608-2-011	K-11	B-37	1608-6-139	K-55	B-39	2108-105	SO6-105	B-6

STRYKER-STYLE BLADES, BURS + RASPS

Stryker	MicroAire	Page	Stryker	MicroAire	Page	Stryker	MicroAire	Page
2108-105	SO-605	B-15	2108-152	SO6-152	B-8	2108-309	SO6-309	B-12
2108-109	SO6-109	B-6	2108-155	SO6-155	B-8	2108-309	SO-6309	B-17
2108-109	SO-609	B-15	2108-155	SO-655	B-19	2108-310	SO6-310	B-12
2108-110	SO6-110	B-7	2108-156	SO6-156	B-9	2108-318	SO-6318	B-17
2108-110	SO-610	B-16	2108-156	SO-656	B-19	2108-351	SO-651	B-18
2108-111	SO6-111	B-7	2108-158	SO6-158	B-9	2108-351	SO-699	B-21
2108-111	SO-611	B-16	2108-158	SO-658	B-19	2108-352	SO-6352	B-17
2108-113	SO6-113	B-7	2108-160	SO6-160	B-9	2108-356	SO6-356	B-12
2108-115	SO6-115	B-7	2108-160	SO-660	B-19	2108-356	SO-6356	B-17
2108-115	SO-615	B-16	2108-175	SO6-175	B-9	2108-359	SO-6580	B-17
2108-118	SO6-118	B-7	2108-176	SO6-176	B-9	2108-377	SO-677	B-20
2108-118	SO-618	B-16	2108-176	SO-676	B-20	2108-382	SO-682	B-20
2108-120	SO6-120	B-7	2108-177	SO6-177	B-9	2108-383	SO-683	B-20
2108-120	SO-620	B-16	2108-182	SO6-182	B-10	2108-385	SO-685	B-20
2108-125	SO-625	B-35	2108-182-10	SO6-182-10	B-10	2109-140	SO-640	B-18
2108-125	SO6-125	B-34	2108-183	SO6-183	B-10	2206-33-115	SP-115A	B-27
2108-131	SO6-131	B-7	2108-185	SO6-185	B-10	2296-22-103	SP-103A	B-25
2108-137	SO-637	B-35	2108-189	SO6-189	B-10	2296-23-105	SP-23-105	B-29
2108-137	SO6-137	B-34	2108-189	SO-689	B-20	2296-23-111	SP-23-111	B-29
2108-140	SO6-140	B-7	2108-193	SO6-193	B-10	2296-23-412	SP-23-412	B-29
2108-144	SO6-144	B-8	2108-195	SO6-195	B-11	2296-23-414	SP-23-414	B-29
2108-145	SO6-145	B-8	2108-197	SO6-197	B-11	2296-3-101	SP-101	B-25
2108-145	SO-645	B-18	2108-218	SO6-218	B-11	2296-3-102	SP-102	B-25
2108-148	SO6-148	B-8	2108-218	SO-718	B-21	2296-3-103	SP-103	B-25
2108-148	SO-648	B-18	2108-302	SO6-302	B-11	2296-3-104	SP-104	B-25
2108-150	SO6-150	B-8	2108-302	SO-6302	B-16	2296-3-105	SP-105	B-25
2108-150	SO-650	B-18	2108-305	SO6-305	B-12	2296-3-106	SP-106	B-26
2108-151	SO6-151	B-8	2108-305	SO-6305	B-17	2296-3-108	SP-108	B-26

STRYKER-STYLE BLADES, BURS + RASPS

Stryker	MicroAire	Page	Stryker	MicroAire	Page	Stryker	MicroAire	Page
2296-3-111	SP-111	B-26	2296-33-220	SP-220A	B-28	2296-3-525	SP-525	B-31
2296-3-114	SP-114	B-26	2296-33-221	SP-221A	B-28	2296-3-528	SP-528	B-32
2296-3-115	SP-115	B-26	2296-33-224	SP-224A	B-28	2296-3-529	SP-529	B-32
2296-3-121	SP-121	B-27	2296-33-225	SP-225A	B-28	2296-3-530	SP-530	B-32
2296-3-125	SP-125	B-27	2296-33-234	SP-234A	B-29	277-31-103	SO-103	B-23
2296-3-150	SP-150	B-27	2296-33-410	SP-410A	B-29	277-31-34	SO-434	B-24
2296-3-151	SP-151	B-27	2296-33-411	SP-411A	B-30	277-31-410	SO-410	B-23
2296-3-152	SP-152	B-27	2296-33-412	SP-412A	B-30	277-31-411	SO-411	B-23
2296-3-155	SP-155	B-27	2296-33-413	SP-413A	B-30	277-31-412	SO-412	B-23
2296-3-194	SP-194	B-27	2296-33-414	SP-414A	B-30	277-31-413	SO-413	B-23
2296-3-206	SP-206	B-27	2296-33-519	SP-519A	B-30	277-31-414	SO-414	B-23
2296-3-212	SP-212	B-28	2296-33-520	SP-520A	B-31	277-31-415	SO-415	B-24
2296-3-214	SP-214	B-28	2296-33-521	SP-521A	B-31	277-31-416	SO-416	B-24
2296-3-221	SP-221	B-28	2296-33-522	SP-522A	B-31	277-31-417	SO-417	B-24
2296-3-225	SP-225	B-28	2296-33-526	SP-526A	B-31	277-87-100	SR-027	B-36
2296-3-255	SP-255	B-29	2296-3-410	SP-410	B-29	277-88-125	SO-125	B-34
2296-33-101	SP-101A	B-25	2296-3-411	SP-411	B-29	277-96-250	SR-250	B-22
2296-33-102	SP-102A	B-25	2296-3-412	SP-412	B-30	277-96-251	SR-251	B-22
2296-33-103	SP-103A	B-25	2296-3-413	SP-413	B-30	277-96-275	SR-275	B-22
2296-33-104	SP-104A	B-25	2296-3-414	SP-414	B-30	277-96-277	SR-277	B-22
2296-33-105	SP-105A	B-26	2296-3-504	SP-504	B-30	277-96-281	SR-281	B-22
2296-33-106	SP-106A	B-26	2296-3-506	SP-506	B-30	277-96-300	SR-300	B-22
2296-33-108	SP-108A	B-26	2296-3-508	SP-508	B-30	277-96-325	SR-325	B-22
2296-33-111	SP-111A	B-26	2296-3-51	SP-051	B-25	277-96-326	SR-326	B-22
2296-33-114	SP-114A	B-26	2296-3-511	SP-511	B-31	296-31-410	SO-510	B-23
2296-33-125	SP-125A	B-27	2296-3-515	SP-515	B-31	296-31-412	SO-512	B-23
2296-33-206	SP-206A	B-28	2296-3-521	SP-521	B-31	296-31-413	SO-513	B-23
2296-33-212	SP-212A	B-28	2296-3-524	SP-524	B-31	296-31-415	SO-515	B-23

STRYKER-STYLE BLADES, BURS + RASPS

Stryker	MicroAire	Page	Stryker	MicroAire	Page	Stryker	MicroAire	Page
298-07-10155	SR-101L	B-36	4118-127-090	SO618-127-090	B-4	4125-147-090	SO25-147-090	B-15
298-97-100	SR-100	B-36	4118-127-090	SO18-127-090	B-13	5100-013-113	SR-51-082	B-42
298-97-101	SR-101	B-36	4118-127-100	SO618-127-100	B-4	5100-037-114	SR-51-083	B-42
4111-089-075	SO611-089-075	B-3	4118-127-100	SO18-127-100	B-13	5100-037-115	SR-51-080	B-42
4111-089-075	SO11-089-075	B-13	4118-135-090	SO618-135-090	B-4	5100-037-116	SR-51-081	B-42
4111-089-090	SO611-089-090	B-3	4118-135-090	SO18-135-090	B-13	5100-037-233	SR-51-007T	B-32
4111-089-090	SO11-089-090	B-13	4118-135-105	SO618-135-105	B-4	5100-137-103	SR-51-137-103	B-32
4111-107-090	SO611-107-090	B-3	4118-147-105	SO618-147-105	B-4	5100-137-106	SR-51-137-106	B-32
4111-107-090	SO11-107-090	B-13	4118-147-105	SO18-147-105	B-14	5100-137-111	SR-51-137-111	B-32
4111-119-090	SO611-119-090	B-3	4125-064-075	SO625-064-075	B-4	5100-137-111	SR-51-137-44	B-33
4111-119-090	SO11-119-090	B-13	4125-064-075	SO25-064-075	B-14	5100-137-12	SR-51-137-12	B-32
4111-127-090	SO611-127-090	B-3	4125-089-075	SO625-089-075	B-4	5100-137-120	SR-51-137-120	B-32
4111-127-090	SO11-127-090	B-13	4125-089-075	SO25-089-075	B-14	5100-137-121	SR-51-137-121	B-32
4111-135-090	SO611-135-090	B-3	4125-089-090	SO625-089-090	B-5	5100-137-123	SR-51-723	B-33
4111-135-090	SO11-135-090	B-13	4125-089-090	SO25-089-090	B-14	5100-137-133	SR-51-733	B-33
4111-147-075	SO611-147-075	B-3	4125-097-090	SO625-097-090	B-5	5100-137-20	SR-51-137-20	B-33
4111-147-075	SO11-147-075	B-13	4125-097-090	SO25-097-090	B-14	5100-137-233	SR-51-007	B-32
4113-119-090	SO613-119-090	B-3	4125-107-090	SO625-107-090	B-5	5100-337-107	SR-51-337-107	B-33
4113-119-090	SO13-119-090	B-13	4125-107-090	SO25-107-090	B-14	5100-337-111	SR-51-337-111	B-33
4118-089-075	SO618-089-075	B-4	4125-119-090	SO625-119-090	B-5	5100-337-12	SR-51-337-12	B-33
4118-089-075	SO18-089-075	B-13	4125-119-090	SO25-119-090	B-14	5100-337-121	SR-51-337-121	B-33
4118-089-090	SO18-089-090	B-13	4125-127-090	SO625-127-090	B-5	5100-337-123	SR-51-337-123	B-33
4118-097-090	SO618-097-090	B-4	4125-127-090	SO25-127-090	B-14	5100-337-133	SR-51-733L	B-33
4118-097-090	SO18-097-090	B-13	4125-127-100	SO625-127-100	B-5	5100-337-20	SR-51-337-20	B-33
4118-119-090	SO618-119-090	B-4	4125-127-100	SO25-127-100	B-14	5100-337-233	SR-51-007L	B-32
4118-125-105	SO18-135-105	B-14	4125-135-090	SO625-135-090	B-5	840-40-350	CC-1000NS	B-36
4118-127-075	SO618-127-075	B-4	4125-135-090	SO25-135-090	B-14			
4118-127-075	SO18-127-075	B-13	4125-147-090	SO625-147-090	B-5			

STRYKER-STYLE DRILLS, PINS + WIRES

Stryker	MicroAire	Page	Stryker	MicroAire	Page
1346-1	1600-435NS	A-42*	5500-119-40	1640-109T	A-43*
1346-2	1600-635NS	A-42*	5500-119-48	1648-109T	A-43*
1346-26	1600-628NS	A-42*	5500-19-20	1620-109	A-43*
1346-3	1600-445NS	A-42*	5500-19-24	1624-109	A-43*
1346-4	1600-645NS	A-42*	5500-19-28	1628-109	A-43*
1346-5	1600-462NS	A-42*	5500-19-32	1632-109	A-43*
1346-6	1600-662NS	A-42*	5500-19-36	1636-109	A-43*
5300-4-28	1600-428	A-42*	5500-19-40	1640-109	A-43*
5300-4-35	1600-435	A-42*	5500-19-48	1648-109	A-43*
5300-4-45	1600-445	A-42*	5500-219-20	1620-709	A-43*
5300-4-54	1600-454	A-42*	5500-219-24	1624-709	A-43*
5300-4-62	1600-462	A-42*	5500-219-28	1628-709	A-43*
5300-6-28	1600-628	A-42*	5500-219-32	1632-709	A-43*
5300-6-35	1600-635	A-42*	5500-219-36	1636-709	A-43*
5300-6-45	1600-645	A-42*	5500-219-40	1640-709	A-43*
5300-6-54	1600-654	A-42*	5500-219-40	1648-709	A-43*
5300-6-62	1600-662	A-42*	5500-319-20	1620-709T	A-43*
5300-9-35	1600-935	A-42*	5500-319-24	1624-709T	A-43*
5300-9-45	1600-945	A-42*	5500-319-28	1628-709T	A-43*
5300-9-54	1600-954	A-42*	5500-319-32	1632-709T	A-43*
5300-9-62	1600-962	A-42*	5500-319-36	1636-709T	A-43*
5500-119-20	1620-109T	A-43*	5500-319-40	1640-709T	A-43*
5500-119-24	1624-109T	A-43*	5500-319-40	1648-709T	A-43*
5500-119-28	1628-109T	A-43*			
5500-119-32	1632-109T	A-43*			
5500-119-36	1636-109T	A-43*			

* Download catalog section A on www.microaire.com to view product page

To search by manufacturer part number or dimensions, visit www.microaire.com

Stryker®

B-47

All dimensions shown are nominal values subject to standard variances and tolerances.

MicroAire® is a registered trademark of MicroAire Surgical Instruments LLC.

The following companies are not affiliated with MicroAire Surgical Instruments LLC:

Conmed Corporation
Dyonics, Inc
Harris/Aesculap
Jacobs
Linvatec Corporation
Stryker
Synthes (USA)
Terumo
Zimmer, Inc

Dyonics® is a trademark of Smith&Nephew

Jacobs® is a registered trademark of Jacobs

Linvatec®, Hall®, Cebotome™, Osteon™, and Neurairtome™ Mini-Driver®, Maxi-Driver® and Maxion™ are trademarks of Linvatec® Corporation, a subsidiary of ConMed Corporation.

Stryker® is a registered trademark of Stryker Corporation

Synthes® is a registered trademark of DePuy Synthes

Terumo® is a registered trademark of Terumo Medical Corporation

Zimmer® is a registered trademark of Zimmer, Inc

MICROAIRE®
For Surgery. For Life.™

MicroAire Surgical Instruments

3590 Grand Forks Boulevard
Charlottesville, VA 22911 USA
800 722 0822 or +434 975 8000
www.microaire.com

© 2016 MicroAire Surgical Instruments, LLC
All rights reserved. LIT-DISPOSABLES-CAT REV A



A COLSON ASSOCIATE



Synthes® Blades
for Large-Bone Power Systems

C-2

Synthes® Twist Drills + Taps

C-4

Dyonics® Blades
for Large-Bone Power Systems

C-6

SYNTHES® and **DYONICS®**

MICROAIRE®
For Surgery. For Life.™

Blades, Twist Drills, Taps and Burs

BLADES for Large-Bone Power Systems

Oscillating Saw Blades

Synthes®

Compact Air Drive, Power Drive, Air Power Line, and Battery Power Line

To cross-reference to Synthes® by part number, replace "AO" with "519"



Part No.	Width (mm)	Usable Length (mm)	Cut Thickness (mm)	Material Thickness (mm)	TPI
AO-107	19	95	0.90	0.90	15
AO-108	25	95	0.90	0.90	15
AO-114	19	95	1.27	1.27	15
AO-115	25	95	1.27	1.27	15
AO-116	19	95	1.35	1.35	15

Synthes® Compact Air Drive, Power Drive, Air Power Line, and Battery Power Line To cross-reference to Synthes® by part number, replace "AO" with "519"

Part No.	Width (mm)	Usable Length (mm)	Cut Thickness (mm)	Material Thickness (mm)	TPI
AO-117	25	95	1.35	1.35	15
AO-118	12.5	90	0.90	0.90	15

TWIST DRILLS

MicroAire® Synthes®-Style Drill Models 1990, 5990, 6690 and 7100-006 Sold individually. To order non-sterile, add "NS" to the end of the product number (e.g. 8053-XXXNS).

Type	Diameter (mm)	Overall Length (mm)	Usable Length (mm)	MicroAire Part #	Replaces Synthes® #	
Quick-Connect Style <i>Fits Synthes-Style Drill Couplers</i>	1.1	60	35	8053-011	310.11	
	1.5	85	60	8053-015	310.15	
		110	85	8053-016	310.16	
	2.0	100	75	8053-019	310.19	
		125	100	8053-021	310.21	
	2.5	180	155	8053-023*	310.23	
		110	85	8053-025*	310.25	
	2.7	100	75	8053-026	310.26	
		125	100	8053-028	310.28	
	3.2	195	170	8053-029	310.29	
		145	120	8053-031	310.31	
	3.5	110	85	8053-035	310.35	
		195	170	8053-037	310.37	
	4.5	145	120	8053-044	310.44	
		195	170	8053-048	310.48	
	6.0	195	170	8053-060	310.60	
Jacobs Style <i>Fits Jacobs Drive Couplers and Adapters</i>	2.0	85	27	8053-020	310.20	
	2.5	95	60	8053-024	310.24	
	3.2	130	85	8053-032	310.32	
	3.5	95	60	8053-036	310.36	

*Titanium nitride-coated

TAPS



MicroAire® Synthes®-Style Drill Models 1990, 5990, 6690 and 7100-006 Sold individually. To order non-sterile, add "NS" to the end of the product number (e.g. 8053-XXXNS).

Diameter (mm)	Overall Length (mm)	Usable Length (mm)	MicroAire Part #	Replaces Synthes® #	Use With	For Use with Screw Type
1.5	52	20	8053-115	311.15	1.1 mm drill bit	1.5 mm cortex screw
2.0	54	24	8053-119	311.19	1.5 mm drill bit	2.0 mm cortex screw
2.7	100	35	8053-126	311.26	2.0 mm drill bit	2.7 mm cortex screw
3.5	111	46	8053-132*	311.32	2.5 mm drill bit	3.5 mm cortex & titanium shaft screws
	181	51	8053-133*	311.33	2.5 mm drill bit	3.5 mm cortex & titanium shaft screws
4.0	111	48	8053-134	311.34	2.5 mm drill bit	4.0 mm cancellous screws
4.5	130	70	8053-146	311.46	3.2 mm drill bit	4.5 mm cortex & titanium shaft screws
	180	83	8053-148	311.48	3.2 mm drill bit	4.5 mm cortex & titanium shaft screws



*Titanium nitride-coated

BLADES for Large-Bone Power Systems

Oscillating Saw Blades

Dyonics® Sagittal Saw 2855

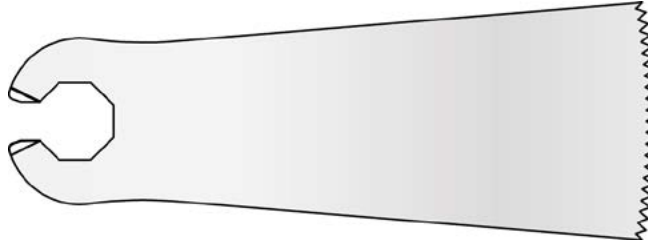
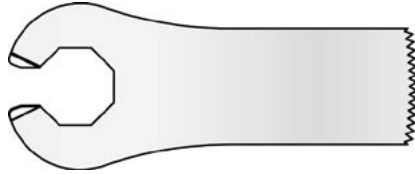
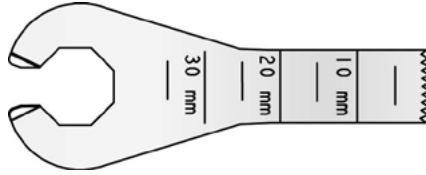
To cross-reference to Dyonics® by part number, replace "DO-" with "3"

Part No.	Width (mm)	Usable Length (mm)	Cut Thickness (mm)	Material Thickness (mm)	TPI	
DO-701	31.2	60	1.0	0.60	16	
DO-703	15.3	30	1.0	0.60	16	
DO-704	9.2	30	1.0	0.60	16	
DO-705	13.2	60	1.0	0.60	16	

SYNTHESES-STYLE BLADES

Synthes	MicroAire	Page
519.107	AO-107	C-2
519.108	AO-108	C-2
519.114	AO-114	C-2
519.115	AO-115	C-2
519.116	AO-116	C-2
519.117	AO-117	C-3
519.118	AO-118	C-3

SYNTHESES-STYLE PINS + WIRES

Synthes	MicroAire	Page	Synthes	MicroAire	Page
310.11	8053-011	C-4	310.35	8053-035	C-4
310.15	8053-015	C-4	310.36	8053-036	C-4
310.16	8053-016	C-4	310.37	8053-037	C-4
310.19	8053-019	C-4	310.44	8053-044	C-4
310.20	8053-020	C-4	310.48	8053-048	C-4
310.21	8053-021	C-4	310.60	8053-060	C-4
310.23	8053-023	C-4	311.15	8053-115	C-5
310.24	8053-024	C-4	311.19	8053-119	C-5
310.25	8053-025	C-4	311.26	8053-126	C-5
310.26	8053-026	C-4	311.32	8053-132	C-5
310.28	8053-028	C-4	311.33	8053-133	C-5
310.29	8053-029	C-4	311.34	8053-134	C-5
310.31	8053-031	C-4	311.46	8053-146	C-5
310.32	8053-032	C-4	311.48	8053-148	C-5

All dimensions shown are nominal values subject to standard variances and tolerances.

MicroAire® is a registered trademark of MicroAire Surgical Instruments LLC.

The following companies are not affiliated with MicroAire Surgical Instruments LLC:

Conmed Corporation
Dyonics, Inc
Harris/Aesculap
Jacobs
Linvatec Corporation
Stryker
Synthes (USA)
Terumo
Zimmer, Inc

Dyonics® is a trademark of Smith&Nephew

Jacobs® is a registered trademark of Jacobs

Linvatec®, Hall®, Cebotome™, Osteon™, and Neurairtome™ Mini-Driver®, Maxi-Driver® and Maxion™ are trademarks of Linvatec® Corporation, a subsidiary of ConMed Corporation.

Stryker® is a registered trademark of Stryker Corporation

Synthes® is a registered trademark of DePuy Synthes

Terumo® is a registered trademark of Terumo Medical Corporation

Zimmer® is a registered trademark of Zimmer, Inc

MICROAIRE®
For Surgery. For Life.™

MicroAire Surgical Instruments

3590 Grand Forks Boulevard
Charlottesville, VA 22911 USA
800 722 0822 or +434 975 8000
www.microaire.com

© 2016 MicroAire Surgical Instruments, LLC
All rights reserved. LIT-DISPOSABLES-CAT REV A



A COLSON ASSOCIATE